



I COLORI, COME I LINEAMENTI,
SEGUONO I CAMBIAMENTI DELLE
EMOZIONI.
COLORS, LIKE FEATURES,
FOLLOW THE CHANGES
OF EMOTIONS.

Pablo Picasso



N

C

NEXT
CAPSULE
2024

LE CALDE NOTE DEL NOCE CANALETTO,
PROTAGONISTA DELLA NEXT CAPSULE
2024, GIOCANO CON I MORBIDI TONI
DEL ROSSO BEIGE E DEL MARRONE RAME.
WARM NOTES OF CANALETTO WALNUT,
THE STAR OF THE NEXT CAPSULE 2024,
PLAY WITH SOFT TONES OF BEIGE RED
AND COPPER BROWN.

24

SCAPPINI

HOME



NEXT

NEXT 2024 DISEGNA NUOVI SCENARI CON ARMONIOSI ELEMENTI IDENTITARI, COME IL CERCHIO E INNOVAZIONI DINAMICHE CHE SCANDISCONO LO SPAZIO, ILLUMINANDOLO CON CROMIE INEDITE E MATERIALI SUGGESTIVI. IL NOCE CANALETTO CHE DEFINISCE IL MOOD DELLA COLLEZIONE, DIALOGA CON IL NERO ASSOLUTO DEL METALLO, CON IL FOREST MAGNOLIA DEL QUARZO E CON LE AVVOLGENTI NUANCES MARRONE RAME, ROSSO BEIGE, GIALLO MIELE E BLU OCEANO DELLE LACCHE CHE CREANO LA CORNICE DELLA CASA NEXT.

DESIGN OTTOMANI DESIGN-CRISTINA BERNACCHI

NEXT 2024 DESIGNS NEW SCENARIOS WITH HARMONIOUS IDENTITARY ELEMENTS, SUCH AS THE CIRCLE AND DYNAMIC INNOVATIONS THAT MARK THE SPACE, ENLIGHTENING IT WITH NEW HUES AND EVOCATIVE MATERIALS. THE CANALETTO WALNUT WHICH DEFINES THE MOOD OF THE COLLECTION, DIALOGUES WITH THE ABSOLUTE BLACK OF THE METAL, WITH FOREST MAGNOLIA OF THE QUARTZ AND WITH THE ENVELOPING COPPER BROWN, BEIGE RED, HONEY YELLOW AND OCEAN BLUE NUANCES OF THE LACQUERS THAT CREATE THE SETTING OF THE NEXT HOME.



TREE - Libreria Bookcase

L

T

V



I

N

G

”

VEDO OVUNQUE IN NATURA, PER ESEMPIO
 NEGLI ALBERI, CAPACITÀ DI ESPRESSIONE
 E, PER COSÌ DIRE, UN'ANIMA.
 I SEE EVERYWHERE IN NATURE, FOR EXAMPLE
 IN TREES, CAPACITY FOR EXPRESSION AND,
 SO TO SPEAK, A SOUL.

”

Vincent van Gogh



ROTAZIONE E RIVOLUZIONE.

ROTATION AND REVOLUTION.

NERO ASSOLUTO PER L'ALBERO IN METALLO INTORNO AL QUALE RUOTANO MORBIDAMENTE QUATTRO SCAFFALI MAGISTRALMENTE SAGOMATI IN NOCE CANALETTO. DETTAGLI COSTRUTTIVI ECCELLENTI E RIVOLUZIONARI CHE DEFINISCONO E SOTTOLINEANO L'ALTA QUALITÀ DI TREE.

ABSOLUTE BLACK FOR THE METAL MAST AROUND WHICH FOUR SUPERBLY SHAPED SHELVES IN CANALETTO WALNUT ROTATE SOFTLY. EXCELLENT AND REVOLUTIONARY CONSTRUCTION DETAILS THAT DEFINE AND EMPHASIZE THE HIGH QUALITY OF TREE.

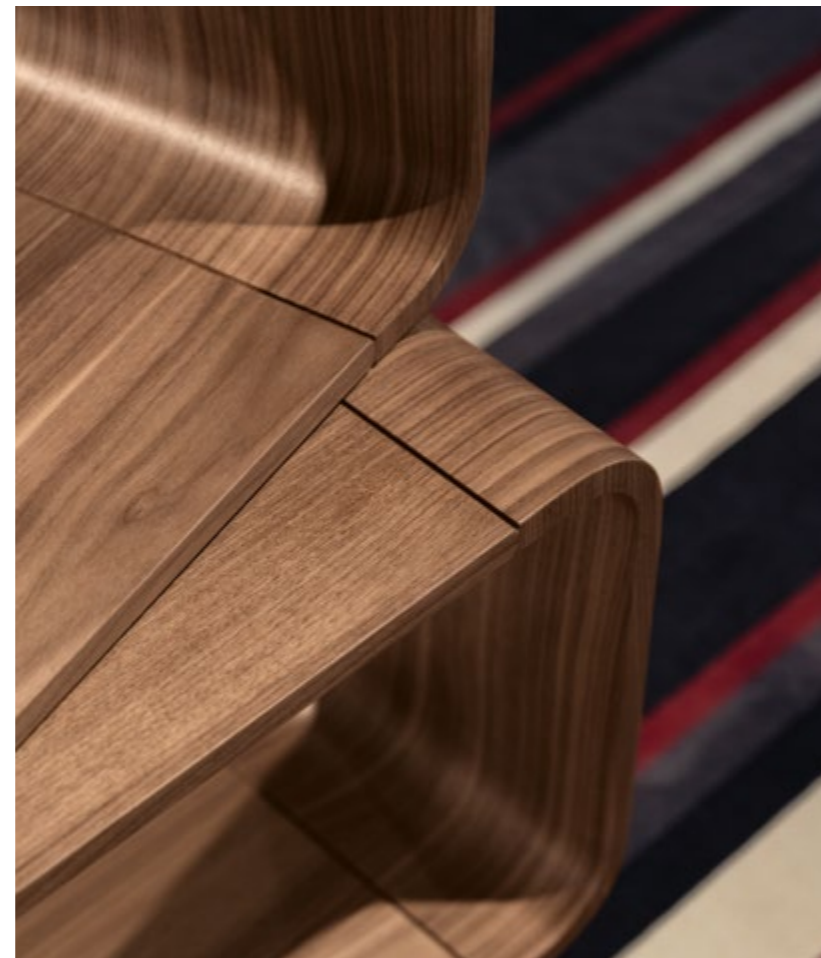

TREE, UN NOME CHE EVOCA FORZA E BELLEZZA. IL NERO, SNELLO ALBERO CENTRALE POGGIA SU UNA SOLIDA BASE ROTONDA. SOSTIENE GLI SCAFFALI CHE GLI RUOTANO INTORNO, CREANDO CONTINUITÀ CON L'AMBIENTE CIRCOSTANTE E MUOVENDOSI IN SIMBIOSI PERFETTA CON CHI ABITA LA CASA. TREE ACCOGLIE E CONTIENE, INGLOBA E SEPARA GLI SPAZI DI OGNI AMBIENTE.

TREE, A NAME THAT EVOKES STRENGTH AND BEAUTY. THE BLACK, SLENDER, CENTRAL MAST RESTS ON A SOLID ROUND METAL BASE. IT SUPPORTS THE SHELVES THAT ROTATE AROUND IT, CREATING CONTINUITY WITH ITS SURROUNDINGS AND MOVING IN PERFECT SYMBIOSIS WITH THOSE WHO LIVE IN THE HOUSE. TREE WELCOMES AND CONTAINS, INCLUDES AND SEPARATES THE SPACES OF EACH AMBIANCE.





TALENTO E BELLEZZA.

TALENT AND BEAUTY.



TALENTO - Scrivania Desk
SWEET - Poltrona girevole Swivel armchair
FLAMINGO - Piantana Floor lamp



**IL PIACERE DI UNO SCRITTOIO DAL FASCINO RÉTRO.
IL LUSO DI LAVORARE SU UN PIANO SPAZIOSO, PROTETTO DALLA
FASCIA IN NOCE CURVATO CHE CREA UN'AREA DI INVIOLABILE PRIVACY.
IL NOCE CANALETTO E IL METALLO LACQUERATO IN NERO ASSOLUTO,
SONO IL BINOMIO VINCENTE E IDENTITARIO DELLA COLLEZIONE 2024.**

THE PLEASURE OF A DESK WITH RÉTRO CHARM. THE LUXURY OF WORKING ON A SPACIOUS TOP, PROTECTED BY THE CURVED WALNUT RISER THAT CREATES AN AREA OF INVIOABLE PRIVACY. THE VERSATILITY OF A DESK THAT CONVERTS TO A VANITY DESK. CANALETTO WALNUT AND METAL LACQUERED IN ABSOLUTE BLACK ARE THE WINNING AND DISTINCTIVE COMBINATION OF THE 2024 COLLECTION.



CRUISE - Credenza Sideboard
 GAZE - Specchio Mirror
 COLIBRI - Lampada da appoggio Table lamp

DINING



NO

G

MI PIACE LO SPIRITO DEL RITROVARSI,
 LA CONVIVIALITÀ SENZA FRONZOLI,
 LA PRESENZA DEI FIOCCHI DI NEVE,
 QUELLA DELLE MURA SPESSIE,
 TENENDO IN MANO UN BICCHIERE DI VINO
 PER UN PAIO D'ORE DI ASSOLUTA SERENITÀ.
 I LIKE THE SPIRIT OF REUNION, THE
 NO-FRILLS CONVIVIALITY, THE PRESENCE OF
 SNOWFLAKES, THAT OF THICK WALLS, HOLDING
 A GLASS OF WINE FOR A COUPLE OF HOURS OF
 ABSOLUTE SERENITY.

Virginia Woolf





UNA CONVIVIALITÀ TUTTA NUOVA SI IMPONE IN QUESTA COLLEZIONE 2024. GLI ELEMENTI IDENTITARI, NOCE CANALETTO, METALLO LACCATO NERO, ANGOLI STONDATI E OBLÒ DEFINISCONO ANCHE TUTTA LA ZONA PRANZO. LA CREDENZA CON IL PIANO IN QUARZO E IL GRANDE TAVOLO CON LE SOTTILI, ELEGANTI SEDUTE, CREANO UN'AREA DI RAFFINATA E SERENA ACCOGLIENZA.

A WHOLE NEW CONVIVIALITY EMERGES IN THIS 2024 COLLECTION. THE IDENTITARY ELEMENTS, CANALETTO WALNUT, BLACK LACQUERED METAL, ROUNDED CORNERS AND PORTHOLES ALSO DEFINE THE ENTIRE DINING ROOM. THE SIDEBOARD WITH THE QUARTZ TOP AND THE LARGE TABLE WITH THE SLIM, ELEGANT SEATS, CREATE AN AREA OF REFINED, SERENE HOSPITALITY.



LA GIOIA DI OSPITARE.

THE JOY OF HOSTING.



DROP - Tavolo Table
LOLA - Sedia Chair
CRUISE - Credenza Sideboard
NEST - Lampadario Chandelier





MOON - Letto Bed
 SHELL - Paravento Paravent
 MID - Tavolino Occasional table
 GAZE - Specchio Mirror



NOTTE,
 MERAVIGLIOSA
 NOTTE.

NIGHT, WONDERFUL NIGHT.

“

CHI DORME TIENE INTORNO A SÉ.
 IN CERCHIO, IL FILO DELLE ORE,
 GLI ORDINI DEGLI ANNI
 E DEI MONDI.
 THE SLEEPER KEEPS AROUND HIM,
 IN A CIRCLE, THE THREAD OF
 HOURS, THE ORDERS OF THE YEARS
 AND OF THE WORLDS.

”

Marcel Proust

T

DUPLICE DIMENSIONE E MATERIALI IN CONTRASTO INTERPRETANO LE NUOVE, INESPLORATE TENDENZE DEL TEMPO DELLA NOTTE. L'AVVOLGENTE MORBIDEZZA DELLA PARTE CENTRALE SI INTERFACCIA CON LA LEGGEREZZA VINTAGE DELLA PAGLIA DI VIENNA CHE, CON LA SUA FAMOSISSIMA TEXTURE, PORTA IN UNA DIMENSIONE CHE INCROCIA PASSATO E FUTURO. IL MORBIDO TONO DORATO DEL NOCE CANALETTO ACCOMPAGNA E SOTTOLINEA IL RIGORE DI COMODINI E COMÒ.

DUAL DIMENSIONS AND CONTRASTING MATERIALS INTERPRET THE NEW, UNEXPLORED TRENDS OF NIGHT TIME. THE ENVELOPING SOFTNESS OF THE MIDDLE PART INTERFACES WITH THE VINTAGE LIGHTNESS OF THE VIENNA STRAW WHICH, WITH ITS TRADEMARK TEXTURE, LEADS INTO A DIMENSION THAT CROSSES PAST AND FUTURE. THE SOFT GOLDEN TONE OF CANALETTO WALNUT ACCOMPANIES AND EMPHASIZES THE RIGOR OF NIGHT TABLES AND CHESTS OF DRAWERS.



MOON - Letto Bed
SHELL - Paravento Paravent
MID - Tavolino Occasional table



UNA TESTIERA A DUE DIMENSIONI RACCONTA UNA NUOVA STORIA DELLA NOTTE

A DUAL-DIMENSION
HEADBOARD TELLS A NEW STORY
OF THE NIGHT.

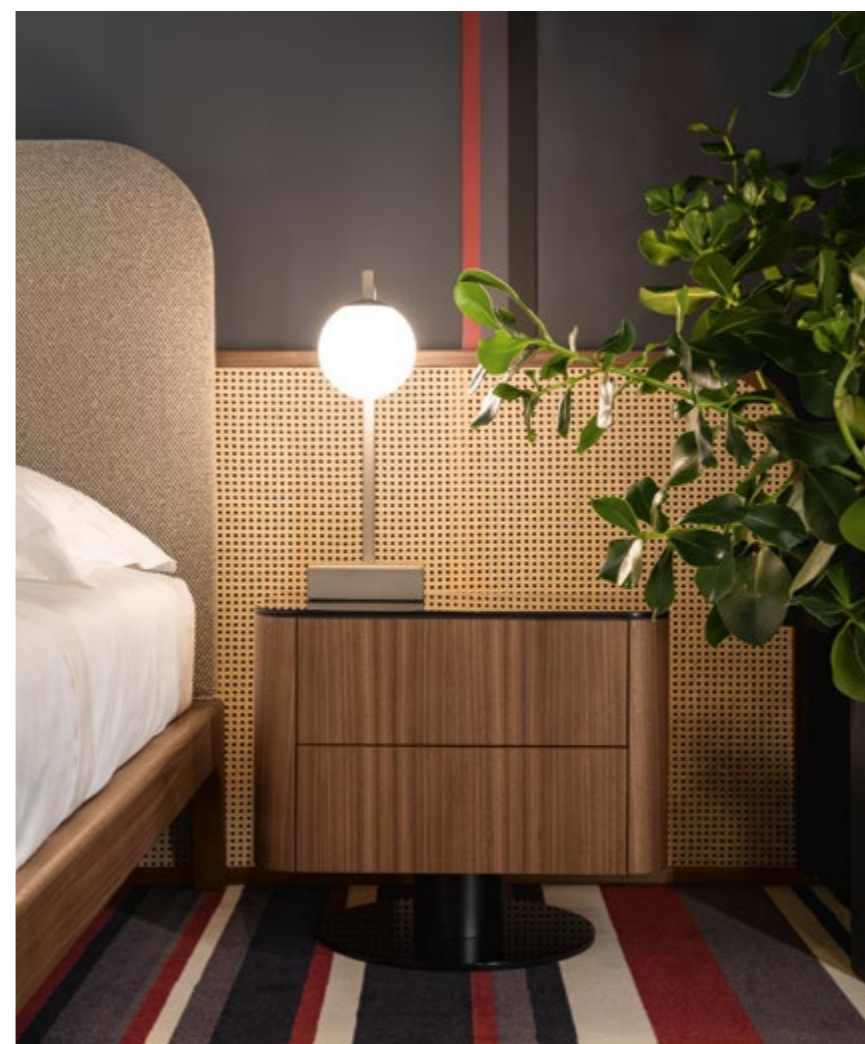

FLY - Comodino Bedside table
COLIBRÌ - Lampada da appoggio Table lamp

DEDICATI ALLA NOTTE ELEMENTI SINTETICI COME IL COMÒ E I COMODINI, IN NOCE CANALETTO DALLA GRANDE BASE STONDATA IN METALLO LACCATO NERO E DALLA SUPERFICIE ESSENZIALE IN VETRO. NELL'AREA NOTTE LO SCRITTOIO DIVENTA COSÌ TOILETTE CON L'AGGIUNTA DELLO SPECCHIO E DI UN MORBIDO POUF.



TWIN - Comò Chest of drawers

DEDICATED TO THE NIGHT, SYNTHETIC ELEMENTS SUCH AS THE DRESSER AND BEDSIDE TABLES, IN CANALETTO WALNUT WITH A LARGE ROUNDED BASE IN BLACK LACQUERED METAL AND AN ESSENTIAL GLASS SURFACE. IN THE BEDROOM, THE DESK THUS BECOMES A DRESSING TABLE WITH THE ADDITION OF A FREE STANDING MIRROR AND A SOFT POUF.



BEAUTY - Toilette Vanity desk
 QUEEN - Specchio Mirror
 EASY - Pouf

TREE N51

libreria noce canaletto
canaletto walnut bookcase

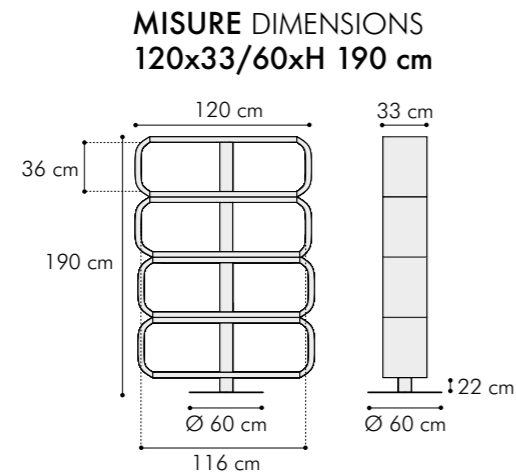

Libreria in NOCE CANALETTO con 4 ripiani
Primo ripiano in basso fisso
3 ripiani girevoli
Base in metallo verniciato NERO

CANALETTO WALNUT bookcase with 4 shelves
First bottom shelf fix
3 revolving shelves
BLACK lacquered metal base

DROP N50

tavolo con piano noce canaletto
canaletto walnut table

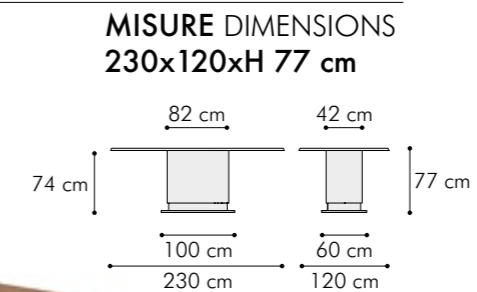

Tavolo da pranzo
con piano impiallacciato NOCE CANALETTO
con bisellatura inferiore
Piedistallo impiallacciato in NOCE CANALETTO
Piastra in metallo verniciato NERO

Dining table
with CANALETTO WALNUT veneered top,
bevelled edge
CANALETTO WALNUT veneered base
BLACK lacquered metal plate

TALENT N48

scrivania
desk



MISURE DIMENSIONS
146x55,5xH 76 cm

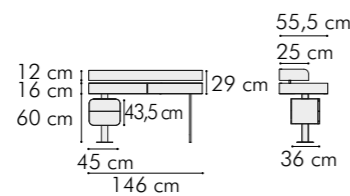

Scrivania
Impiallacciato NOCE CANALETTO,
con 2 cassetti push-pull
Cassettiera a 2 cassetti push-pull
Basi in metallo verniciato NERO

Desk
CANALETTO WALNUT veneered,
with two push-pull opening drawers
Two-drawer chest of drawers push-pull opening
BLACK lacquered metal bases

LOLA N52

sedia
chair



MISURE DIMENSIONS
50x58xH 76 cm

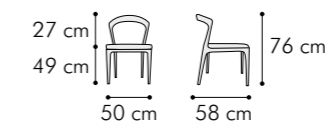

Sedia
Tessuto DOR-GL 004, cat.1
Laccato NERO

Chair
Fabric DOR-GL 004, cat.1
BLACK lacquered

Sedia
Tessuto AZI-GL 905, cat.1
NOCE CANALETTO

Chair
Fabric AZI-GL 905, cat.1
CANALETTO WALNUT

SWEET N47

poltrona girevole
swivel armchair



MISURE DIMENSIONS
58x61xH 89 cm

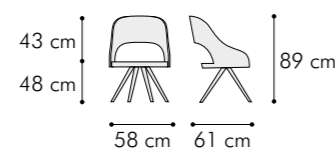

Poltrona girevole
Base girevole: metallo finitura NERO
Rivestimento: pelle DAK-DI 0311, cat. A
Non regolabile in altezza

Swivel armchair
Base: metal BLACK finish
Upholstery: leather DAK-DI 0311, cat. A
Not adjustable in height

CRUISE N49

credenza
sideboard



MISURE DIMENSIONS
160x50xH 79 cm

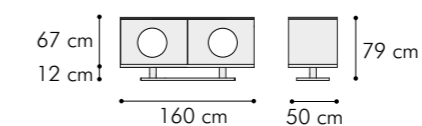

Credenza in NOCE CANALETTO
2 porte con obolo in vetro fumé
2 vani con 1 ripiano regolabile in vetro fumé
dietro ciascun vano
Piano in quarzo PLANET HALLEY 3015 satinato
Piastra in metallo verniciato NERO

Disponibile anche con:
piano in vetro fumé laccato NERO 8 mm
piano in NOCE CANALETTO

CANALETTO WALNUT sideboard
2 doors with smoked glass porthole
2 inner spaces with 1 adjustable smoked shelf
inside each space
Satin PLANET HALLEY 3015 quartz top
BLACK lacquered metal plate

Also available with:
8 mm BLACK lacquered smoked glass top
Canaletto walnut top

MOON N45

letto
bed

MISURE DIMENSIONS
193x211xH 130 cm

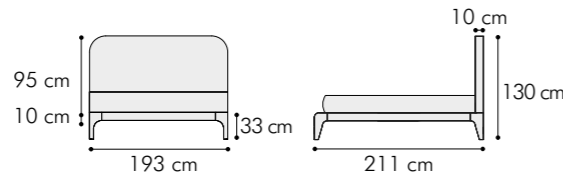

Letto con giroletto in NOCE CANALETTO
Tessuto DOR-GL 004, cat.1
Per rete/materasso cm.180x200
Disponibile su richiesta per qualsiasi misura di rete/materasso

Bed with CANALETTO WALNUT bedframe
Covering: fabric DOR-GL 004, cat.1
For slat/mattress cm.180x200
Available upon request for any size of slat/mattress

FLY N44

comodino
bedside table

MISURE DIMENSIONS
60x43xH 52 cm

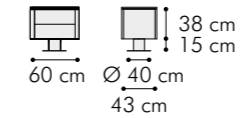

Comodino con 2 cassetti push-pull
impiallacciato NOCE CANALETTO
Piano vetro fumé laccato NERO
oppure NOCE CANALETTO
Piastra in vetro fumé laccato NERO
oppure metallo verniciato NERO

Night table with 2 drawers push-pull
CANALETTO WALNUT veneered
Smoked BLACK lacquered glass top or
CANALETTO WALNUT top
Smoked BLACK lacquered glass plate

SHELL N46

paravento
paravent

MISURE DIMENSIONS
122x3xH 93 cm

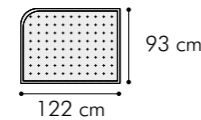

Paravento con profilo in NOCE CANALETTO
ed inserto in paglia di Vienna

Free-standing paravent with CANALETTO WALNUT
frame and Vienna straw insert

BEAUTY N56 / QUEEN N57

toilette / specchio
vanity desk / mirror

MISURE DIMENSIONS
146x55,5xH 76 cm

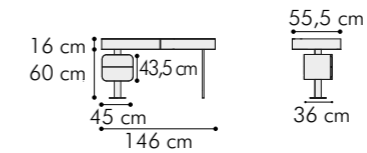

MISURE DIMENSIONS
35x15xH 35 cm



BEAUTY N56
Toilette
Impiallacciato NOCE CANALETTO,
con 2 cassetti push-pull
Cassettiera a 2 cassetti push-pull
Basi in metallo verniciato NERO

QUEEN N57
Specchio ovale con base in vetro
fumé laccato NERO

BEAUTY N56
Vanity desk
CANALETTO WALNUT veneered,
with two push-pull opening drawers
Two-drawer chest of drawers push-pull opening
BLACK lacquered metal bases

QUEEN N57
Free standing oval mirror with
smoked BLACK lacquered glass

TWIN N53

comò
chest of drawers

MISURE DIMENSIONS
160x50xH 79 cm

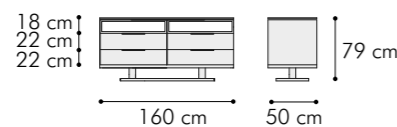

Comò in NOCE CANALETTO
6 cassetti push-pull
Top in vetro fumé laccato NERO
oppure in NOCE CANALETTO
Piastra in metallo verniciato NERO
oppure in vetro fumé laccato NERO

CANALETTO WALNUT chest of drawers
6 drawers with push-pull opening
Smoked BLACK lacquered glass top
or CANALETTO WALNUT top
BLACK lacquered metal plate
or smoked BLACK lacquered glass plate

EASY N23

pouf
pouf

MISURE DIMENSIONS
Ø43xH 46 cm

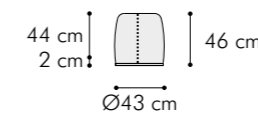

Pouf Ø 43 cm
Rivestimento: Nabuk MON-DI 0855, cat. B
Base: metallo finitura TITANIO

Pouf Ø 43 cm
Upholstery: Nubuck MON-DI 0855, cat. B
Base: metal TITANIUM finish

© Scappini & C srl - 03/2026

CREDITS

Creative direction

Ottomani design - Cristina Bernacchi

Art direction - Graphic design

Adhoc Spazio Creativo

Photography

Lorenzo Borgianni

Press office - Texts

Conversazioni network

THANKS TO

Studio dimore collection

SCAPPINI
HOME

SCAPPINI & C Srl
Via della Serenissima, 9
37051 Bovolone (Verona) - Italy
Tel. +39 045 710 3611
scappini@scappini.it
www.scappinhome.it

