



NEXT

SCAPPINI
HOME

**“UN DESIGN RACCONTA UN DIALOGO PERFETTO FRA OGNI ELEMENTO
NECESSARIO PER DARE VITA AD UNA PERFETTA SINFONIA.
LA TUA CASA, IL LUOGO DOVE RACCONTARE LA TUA STORIA...”**

“A DESIGN TELLS ABOUT THE RIGHT DIALOGUE BETWEEN EVERY
NECESSARY ELEMENT TO CREATE A PERFECT SYMPHONY.
YOUR HOME, THE PLACE WHERE TO TELL YOUR STORY...”

by Ottomani Design

SCAPPINI
HOME

WHAT'S NEXT

NEXT è la genesi dei nostri desideri, l'inizio delle nostre emozioni.

È creata per coloro che cercano forme, materia e dettagli in uno stile che unisce bellezza e funzionalità. NEXT è caratterizzata da un design asimmetrico, è uno scomposto lineare tra lucido ed opaco, tra liscio e ondulato, tra dentro e fuori. Una gamma accattivante di colori e trame donano ad ogni stanza un'atmosfera elegante e personalizzabile in ogni dettaglio. Riflessi, immagini, sensazioni.

Questo è quello che abbiamo voluto trasmettere con NEXT, un'ispirazione interamente italiana che esprime la nostra creatività e amore per il bello.

WHAT'S NEXT

NEXT is the genesis of our desires, the beginning of our emotions.

It is created to meet the research for shapes, material and details in a style which combines beauty and functionality. NEXT collection is characterized by an asymmetrical design, it is a linear breaking up between glossy and matt, smooth and wavy, inside and outside. A captivating range of colours and textures give to every room an elegant atmosphere, customizable in every single detail. Reflections, images, sensations.

This is what we wanted to convey with NEXT, an original Italian inspiration that expresses our creativity and love for beauty.

MATERIALI DI PREGIO E INNOVAZIONE TECNOLOGICA

La ricercatezza dei materiali ed il loro sapiente accostamento, contraddistinguono la collezione.

Essenze, vernici laccate lucide ed opache, enfatizzate dal motivo del canneté, metalli e marmi ricercati, dettagli in cuoio con impunture a due aghi, velluti e tessuti in vari colori e trame, soffice nabuk e specchi fumé. Vetri colorati e un'innovativa tecnica di stampa digitale che permette di riprodurre fedelmente immagini, texture, materiali naturali e qualsiasi immagine che possa essere fotografata e scansionata in alta definizione, a richiesta del cliente finale.

QUALITY MATERIALS AND TECHNOLOGICAL INNOVATION

The research for materials and their wise combination, distinguish this collection.

Essences of wood, glossy and matt lacquers, enhanced by the canneté wooden pattern, metals and special marbles, leather details with two-needle stitching, velvet and fabrics in different colours and textures, soft nubuck and smoked mirrors. Painted glasses and an innovative digital print technique which accurately reproduces images, textures, natural materials and anything that can be photographed or scanned in high definition, upon customer request.

QUANDO CI CHIEDIAMO... "BENE, QUAL È IL PROSSIMO PASSO?"
SIGNIFICA CHE SIAMO PRONTI A VOLTARE PAGINA.

E VOI? SIETE PRONTI?

WHEN WE ASK OURSELVES... "OK, WHAT'S NEXT?"
IT MEANS THAT WE'RE READY TO MOVE ON TO OTHER THINGS!
AND YOU? ARE YOU READY FOR NEXT?

Chiara, Lorenzo, Giovanni Scappini



LIVING

"UN BUON DIVANO È SPESSO CIÒ CHE C'È DI PIÙ EFFICACE PER IMBASTIRE UNA CONVERSAZIONE."

"A GOOD SOFA IS OFTEN THE MOST EFFECTIVE WAY TO STRIKE UP A CONVERSATION."

Pierre Duc, Arrières-pensées





**LINEE RIGOROSE E CURVE
SINUOSE SI EQUILIBRANO NEGLI
ELEMENTI DELLA COLLEZIONE.
IL METALLO SOSTIENE IL COMFORT
DEL DIVANO, LE GAMBE ESILI
SOSPONDONO LA CONSOLLE,
IL MOTIVO CANNETÉ ALLEGGERISCE
IL MOBILE PORTA TV.**

STRICT LINES AND SINUOUS CURVES
BALANCE EACH OTHER AMONG THE
ELEMENTS OF THIS COLLECTION:
THE METAL SUPPORTS THE COMFORT
OF THE SOFA, THE SLIGHT LEGS
SUSPEND THE CONSOLLE, THE CANNETÉ
WOODEN PATTERN LIGHTENS
THE TV CABINET.







Divano OVER, Consolle AROUND, Piantana FLAMINGO, Pouf EASY, Tavolini SHORT e MID, Lampada da appoggio COLIBRÌ
OVER Sofa, AROUND Console, FLAMINGO Floor lamp, EASY Pouf, SHORT Coffee table, MID Occasional table, COLIBRÌ Table lamp



Divano OVER, Piantana HERON
OVER Sofa, HERON Floor lamp



**I RIVESTIMENTI IN TESSUTI
MATERICI E PREZIOSI ESALTANO
LE FORME. LA PRESENZA DI
DIVERSE CROMIE È UN OMAGGIO
ALL'ELEGANZA E SOTTOLINEA
LA DELICATEZZA DEL DESIGN.**
THE UPHOLSTERY WITH RICH
FABRICS ENHANCES THE SHAPES.
THE COMBINATION OF DIFFERENT
COLOURS IS A TRIBUTE TO
ELEGANCE AND EMPHASIZES
THE DELICACY OF THE DESIGN.





Tavolini UP, MID e SHORT, Piantana FLAMINGO
UP, MID Occasional tables, SHORT Coffee table, FLAMINGO Floor lamp



Mobile bar LOUNGE, Tavolino UP, Piantana FLAMINGO
LOUNGE Bar unit, UP Occasional table, FLAMINGO Floor lamp



Mobile bar LOUNGE, Piantana FLAMINGO, Poltrona SMOKE
LOUNGE Bar unit, FLAMINGO Floor lamp, SMOKE Armchair

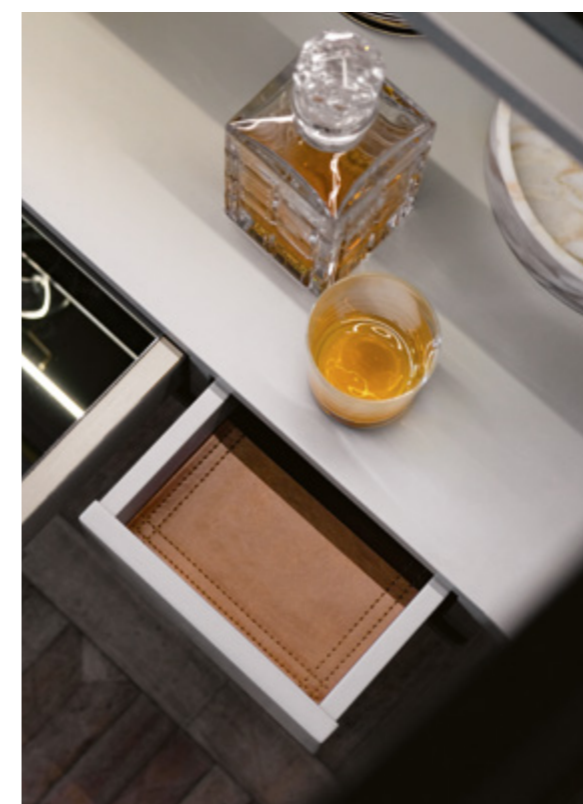

**IL MOBILE COMPONE IL CANNETÉ
CON L'ESSENZA DI EBANO. IL PIANO
È IN VETRO LACCATO CON PROFILO
VERNICIATO OTTONE. ALL'INTERNO
ACCESSORI UTILI E DETTAGLI
PREZIOSI ILLUMINATI CON LUCI LED
CON SENSORE DI APERTURA.**
THE BAR UNIT COMBINES THE
CANNETÉ WOODEN PATTERN
WITH THE EBONY ESSENCE.
LACQUERED GLASS TOP WITH BRASS
VARNISHED PROFILE. INSIDE USEFUL
ACCESSORIES AND PRECIOUS DETAILS
ILLUMINATED WITH OPENING
SENSOR LED LIGHT.



Consolle AROUND, Lampada da appoggio COLIBRÌ, Pouf EASY
AROUND Console, COLIBRÌ Table lamp, EASY Pouf





**IL MOBILE LIBRERIA,
IN ESSENZA DI EBANO, PRESENTA
DIVISORI IN METALLO VERNICIATO
OTTONE CON PIANI IN VETRO FUMÉ,
ILLUMINATI A LED. LA LIBRERIA,
RACCHIUDE IL MOBILE PORTA TV.
EQUIPPED WALL UNIT
IN EBONY ESSENCE WITH BRASS
LACQUERED METAL DIVIDERS, SMOKE
GLASS TOPS WITH LED LIGHT.
THE WALL UNIT IS THE PERFECT FRAME
FOR THE TV CABINET.**



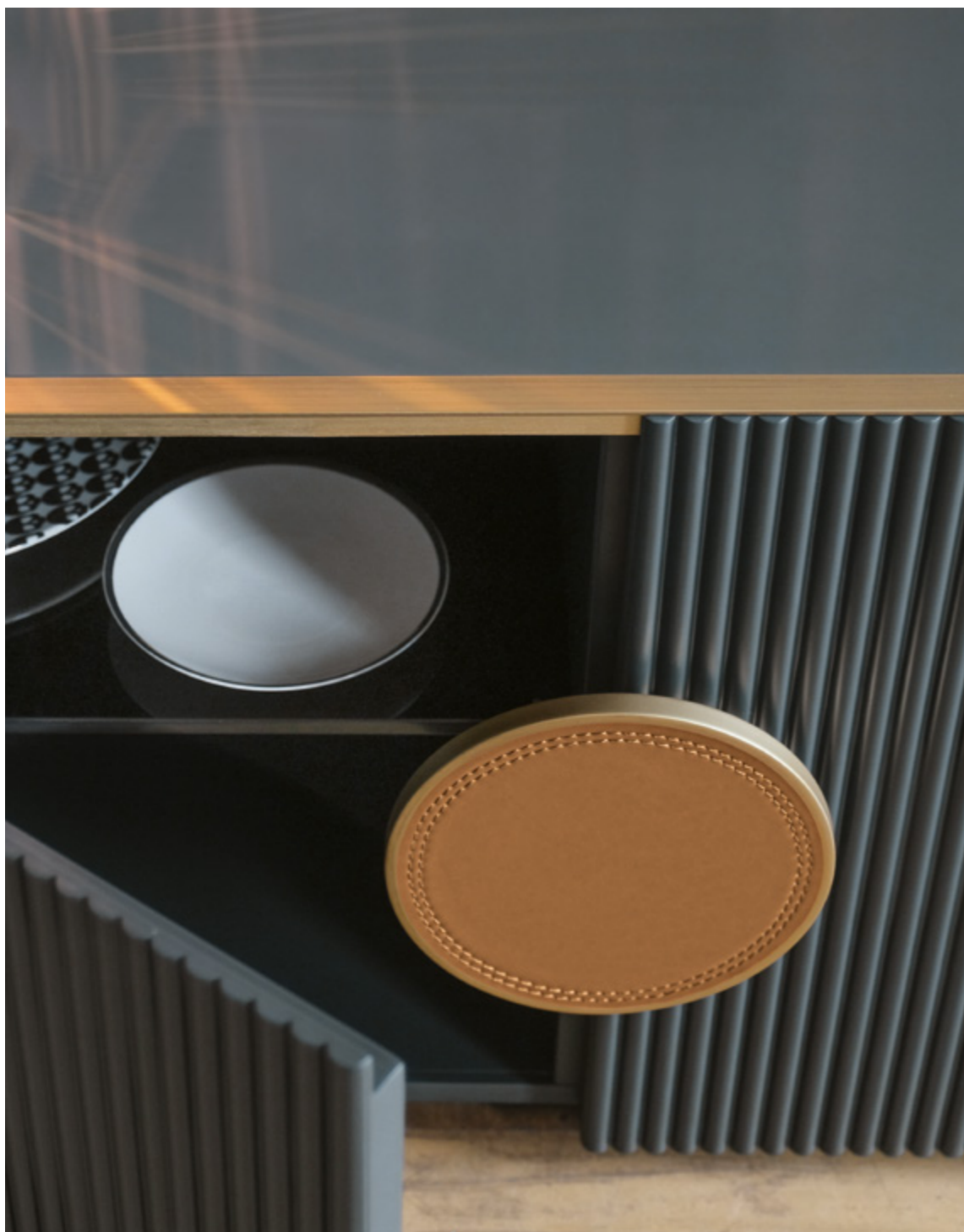



Poltrona SMOKE, Piantana FLAMINGO
SMOKE Armchair, FLAMINGO Floor lamp



LA POLTRONA, RIVESTITA IN MORBIDA PELLE, HA UN ASPETTO INVITANTE E UN CARATTERE LUSSUOSO, ENFATIZZATI DA VOLUMI MARCATI.

IL POGGIATESTA IN PELLE PUÒ ESSERE POSIZIONATO PER IL MASSIMO COMFORT.

THE ARMCHAIR, COVERED WITH SOFT LEATHER, HAS AN INVITING APPEARANCE AND A LUXURIOUS CHARACTER ENHANCED BY MARKED VOLUMES. THE HEADREST CAN BE POSITIONED FOR THE MAXIMUM COMFORT.



Poltrona SMOKE, Pouf PRIZE, Piantana FLAMINGO
SMOKE Armchair, PRIZE Pouf, FLAMINGO Floor lamp









Mensola SURF, Mensola da terra FLAT, Lampada da appoggio EAGLE, Tavolini UP e MID
SURF Shelf, FLAT Floor standing shelf, EAGLE Table lamp, UP and MID Occasional tables



**LA LIBRERIA componibile
 con ripiani a giorno
 o ante in canneté preziosite
 dalla maniglia con inserto
 in vetro laccato, completa
 le pareti del soggiorno, in
 un connubio perfetto di
 funzionalità e design.**

THE MODULAR BOOKCASE WITH OPEN
 SHELVES OR CANNETÉ DOORS,
 EMBELLISHED BY HANDLE WITH
 LACQUERED GLASS INSERT, COMPLETES
 THE WALLS OF THE LIVING ROOM,
 IN A PERFECT COMBINATION OF
 FUNCTIONALITY AND DESIGN.





Divano RODEO, Piantana FLAMINGO, Pouf PRIZE, Tavolino UP
RODEO Sofa, FLAMINGO Floor lamp, PRIZE Pouf, UP Occasional table

Divano RODEO
RODEO Sofa



**FORME RIGOROSE MA
ACCOGLIENTI PER IL DIVANO IN
TESSUTO SALE-PEPE, UN'ELEGANZA
DECLINATA AL MASCHILE DEFINITA
DALLA BASE IN FINITURA TITANIO.**
LINEAR YET COMFORTABLE SHAPES
FOR THE SOFA IN SALT-PEPPER FABRIC,
A MALE ELEGANCE DEFINED BY
THE BASE IN TITANIUM FINISH.



Poltrona DIVA, Piantana FLAMINGO, Tavolino MID
DIVA Armchair, FLAMINGO Floor lamp, MID Occasional table

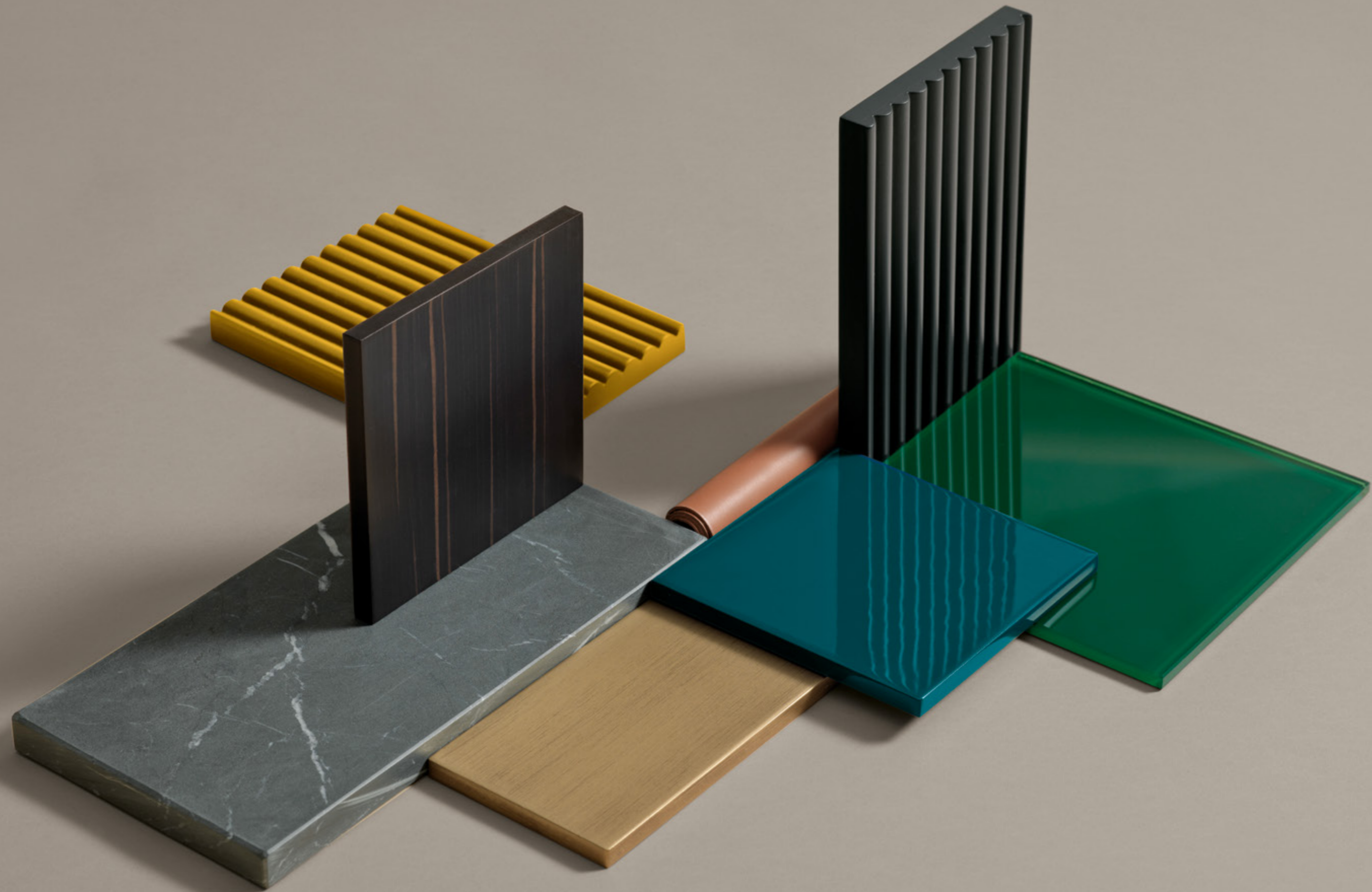

DINING

"NON SI PUÒ PENSARE BENE, AMARE BENE, DORMIRE BENE, SE NON SI HA MANGIATO BENE."

"ONE CANNOT THINK WELL, LOVE WELL, SLEEP WELL, IF ONE HAS NOT DINED WELL."

Virginia Woolf





COLORI DECISI DANNO ALLA COLLEZIONE UNO STILE FORTE E RICONOSCIBILE. METALLO, LEGNI, MARMI, CUIO, VETRI LACCATI SI COMPONGONO IN UN DESIGN DI SPICCATÀ PERSONALITÀ.

DEFINITE COLOURS GIVE TO THE COLLECTION A STRONG AND RECOGNIZABLE STYLE. METALS, WOOD ESSENCES, MARBLES, LEATHER, LACQUERED GLASSES, COMBINE THEMSELVES INTO A DESIGN OF SHARP PERSONALITY.







Sedia EMBRACE, Tavolo ROCK, Piantana FLAMINGO
EMBRACE Chair, ROCK Table, FLAMINGO Floor lamp



**IL SOTTILE PIANO DEL TAVOLO,
IN MARMO OROBICO ROSSO SI
FA NOTARE PER LA SUA DECISA
DELICATEZZA. LA POLTRONCINA
HA LO SCHIENALE IN PELLE,
CON IMPUNTURE A DUE AGHI.**
THE THIN OROBIC RED MARBLE
TOP MAKES ITSELF NOTICE FOR ITS
STRONG DELICACY. THE ARMCHAIR
IS BACK UPHOLSTERED WITH
TWO-NEEDLE STITCHING LEATHER.





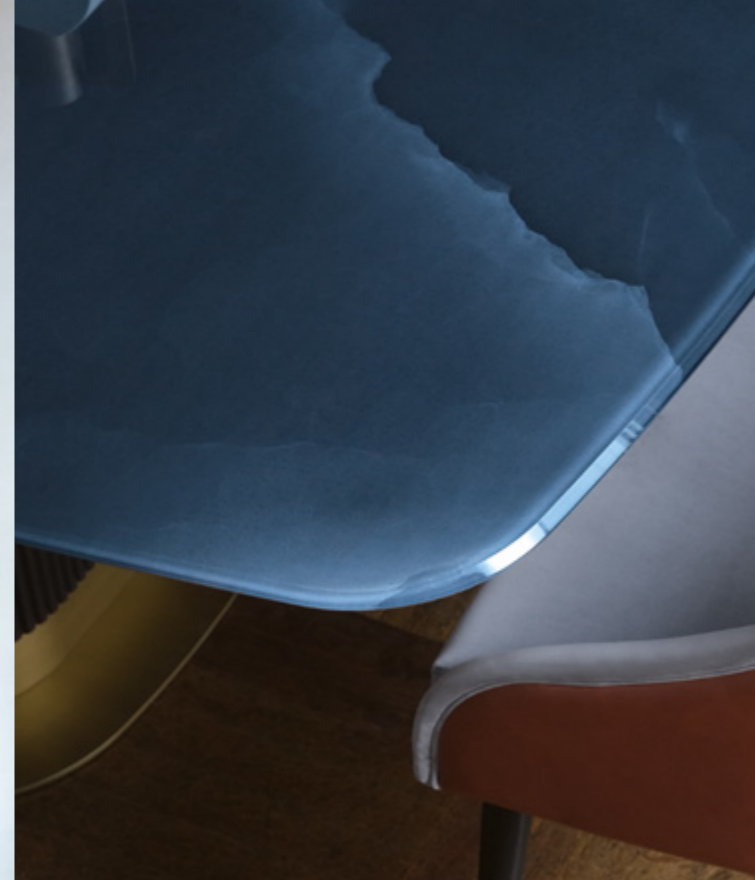

**L'AMORE PER L'INNOVAZIONE
HA DATO VITA AD UN PIANO
IN VETRO CON STAMPA
DIGITALE DI ALTISSIMO
LIVELLO CHE CONDUCE LO
SGUARDO A MIRABILI EFFETTI
DI PROFONDITÀ.**

LOVE FOR INNOVATION
GAVE LIFE TO A GLASS TOP
WITH HIGH LEVEL DIGITAL
PRINT THAT LEADS THE GAZE TO
AMAZING EFFECTS OF DEPTH.





Credenza FACE, Lampada da appoggio EAGLE
FACE Sideboard, EAGLE Table lamp



**IMPORTANTE MA FINE
ED ELEGANTE, LA CREDENZA
COMPONE DUE VOLTI:
UNA SOLIDITÀ ESTERIORE CHE
RACCHIUDE UN SOFISTICATO
EQUILIBRIO INTERNO DI LUCE,
COLORE E RIFLESSI.**

IMPORTANT BUT REFINED
AND ELEGANT, THE SIDEBOARD
MATCHES TWO FACES:
AN EXTERIOR SOLIDITY THAT
HIDES A SOPHISTICATED INNER
BALANCE OF LIGHT, COLOUR
AND REFLECTIONS.



**LA VETRINA SMART SI
CONNOTA PER LA SUA GRANDE
ATTUALITÀ, QUASI SEGUISSE
LE SUGGERZIONI DELLA MODA.
L'INTERNO VIENE VALORIZZATO
DAL CUIO APPLICATO
DA ABILI TAPPEZZIERI ARTIGIANI.**
SMART VITRINE IS DISTINGUISHED
FOR ITS GREAT TOPICAL, AS IF IT
FOLLOWED THE SUGGESTIONS
OF FASHION. THE INTERIOR IS
ENHANCED BY THE BACK LEATHER
APPLIED BY SKILLFUL UPHOLSTERERS.







**UN BILANCIATO CONTRASTO DI
COLORI PER QUESTA CREDENZA A
DUE ANTE. LA STRUTTURA
SI ELEVA SULLA BASE IN
CANNETÉ, DANDO FORMA AD UN
OGGETTO DAL DESIGN ICONICO.
PROTAGONISTA INDICUSSA
LA MANIGLIA CON INSERTO
IN VETRO LACCATO.**

A BALANCED CONTRAST OF
COLORS FOR THIS SIDEBOARD WITH
TWO DOORS. THE STRUCTURE
IS ELEVATED ON A CANNETÉ BASE,
SHAPING AN OBJECT OF ICONIC
DESIGN. INDISPUTABLE PROTAGONIST,
THE HANDLE WITH LACQUERED
GLASS INSERT.

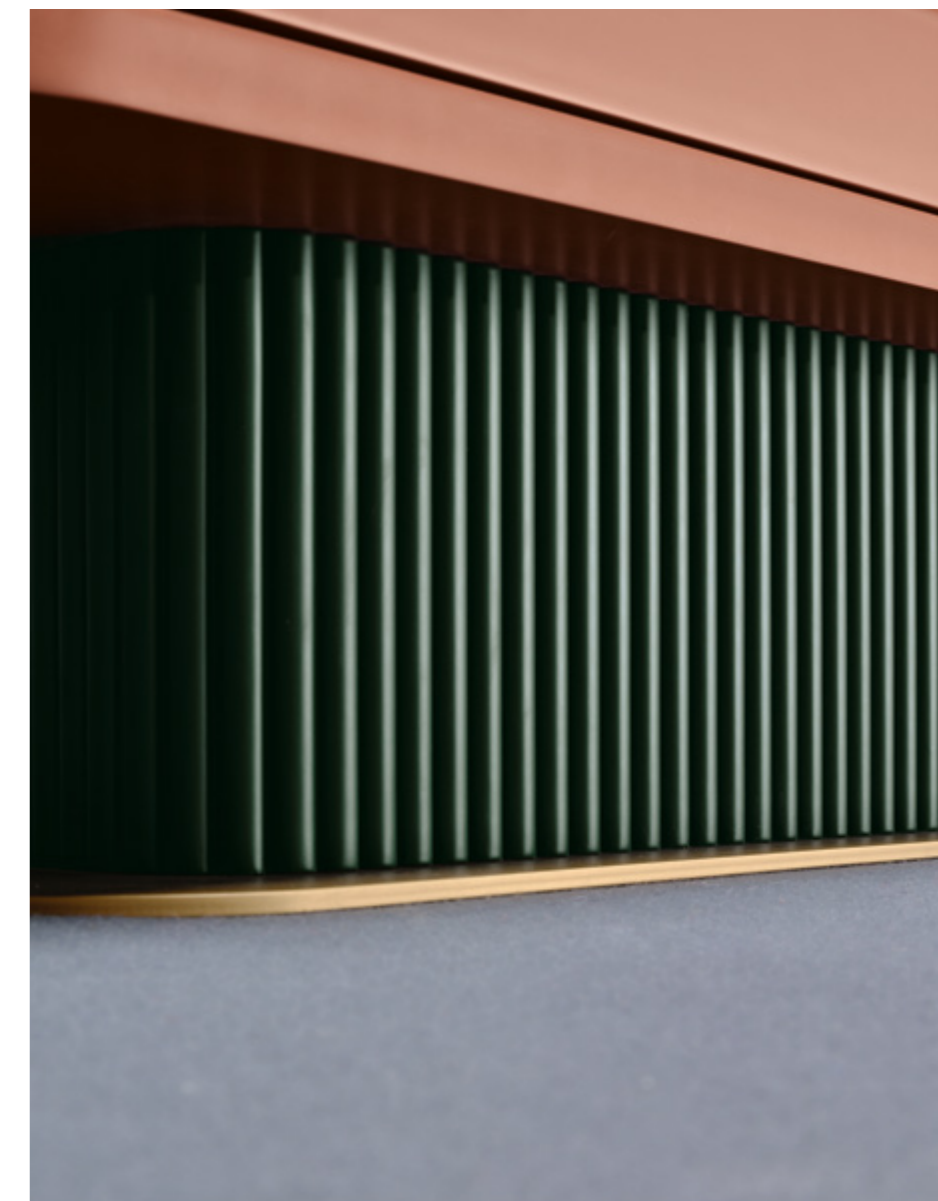



Tavolo DARK, Sedia SPY, Piantana FLAMINGO
DARK Table, SPY Chair, FLAMINGO Floor lamp



**IL TAVOLO ROTONDO È SINONIMO
DI CONVIVIALITÀ. IN MARMO O
IMPIALLACCIATO IN EBANO PUÒ
ESSERE COMPLETATO DA UN
FUNZIONALE PIANO GIREVOLE IN
APPOGGIO, IN VETRO LACCATO O
CON STAMPA DIGITALE.**

THE ROUND TABLE IS
SYNONYMOUS WITH CONVIVIALITY.
IN MARBLE OR EBONY VENEER CAN
BE COMPLETED BY A FUNCTIONAL
SWIVEL TOP IN LACQUERED OR
DIGITAL PRINTED GLASS.







Sedie KISS e SPY
KISS and SPY Chairs







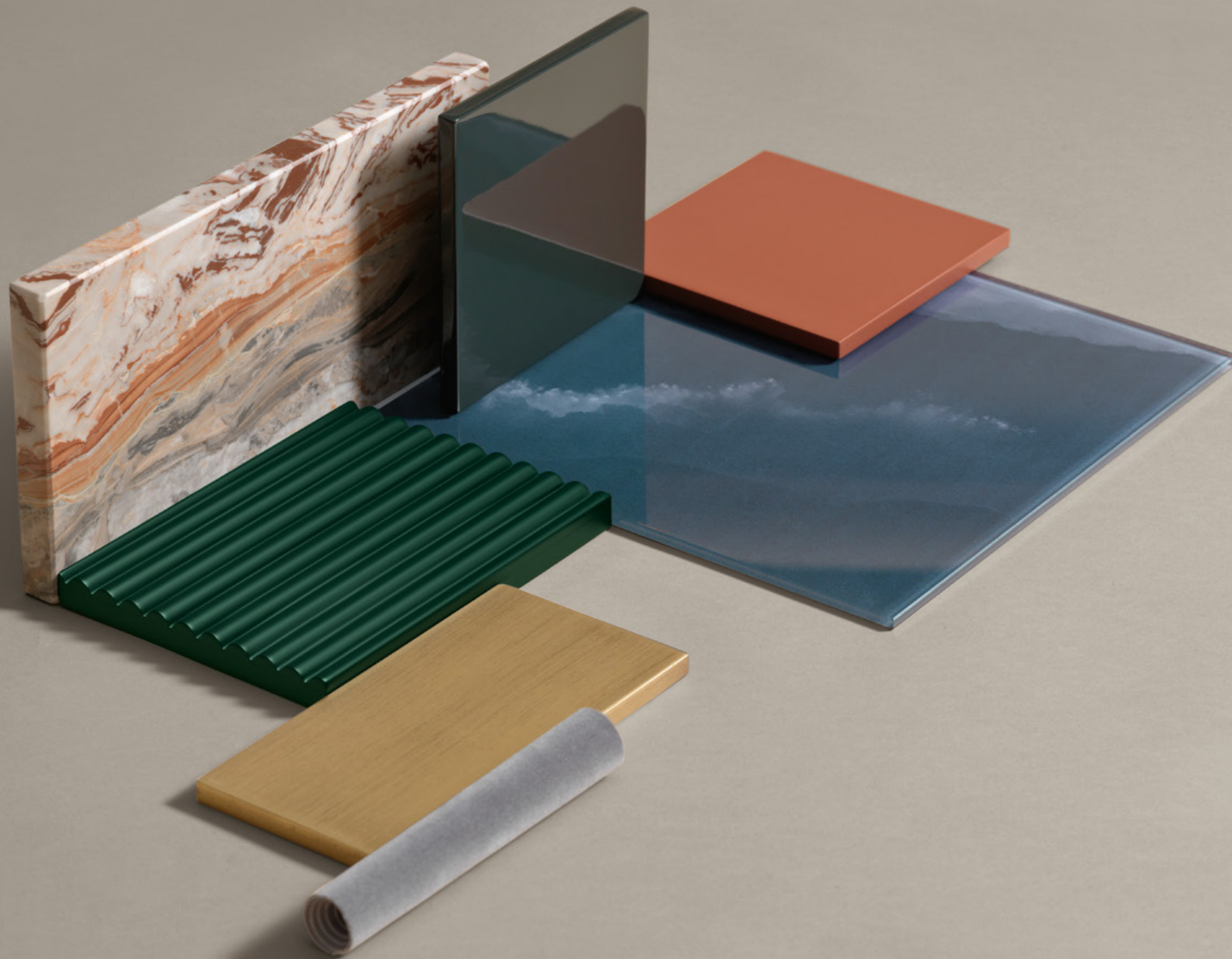

NIGHT

"C'È UN TEMPO PER I LUNGI RACCONTI, E UN TEMPO PER DORMIRE."

"THERE IS A TIME FOR MANY WORDS, AND THERE IS ALSO A TIME FOR SLEEP."

Omero





IL LETTO SI IMPONE CON LA SUA IMPORTANTE TESTATA IMPUNTURATA VERTICALMENTE, RIPRENDE IL MOTIVO CANNETÉ DEGLI ARREDI DELLA COLLEZIONE.

BED STANDS OUT WITH ITS IMPORTANT HEADBOARD, VERTICALLY HAND-SEWN, REMINDING THE CANNETÉ PATTERN OF THE FURNISHINGS OF THE COLLECTION.







Letto BOND, Toilette FANCY, Piantana FLAMINGO, Comodino AWAY, Lampada da appoggio integrata SWAN
 BOND Bed, FANCY Vanity desk, FLAMINGO Floor lamp, AWAY Bedside table, SWAN Built-it table lamp



**DETTAGLIO IMPORTANTE
 È LA FUNZIONALITÀ DELLA
 LAMPADA INGLOBATA NEL
 COMODINO, CON PULSANTE
 TOUCH. LA PANCA È RIVESTITA
 IN PELLE CON CORNICE
 VERNICIATA OTTONE.**

AN IMPORTANT DETAIL IS
 THE PRACTICALITY OF THE TABLE
 LAMP INCLUDED IN THE NIGHT
 TABLE, WITH TOUCH-BUTTON.
 BENCH IS UPHOLSTERED IN LEATHER
 WITH A BRASS LACQUERED
 PROFILE AT ITS BASE.





Panchetta BOUNCE
BOUNCE Bench





Toilette FANCY, Pouf EASY, Piantana FLAMINGO
FANCY Vanity desk, EASY Pouf, FLAMINGO Floor lamp

Toilette FANCY, Pouf EASY, Piantana FLAMINGO, Scatola TREASURE
FANCY Vanity desk, EASY Pouf, FLAMINGO Floor lamp, TREASURE box



**LA TOILETTE, IN LINEA CON
L'INTERA COLLEZIONE SI
VESTE DI UN PIANO IN VETRO
LACCATO; LO SCHIENALE DELLA
SPECCHIERA È GENIALMENTE
ADIBITO AD APPENDIABILI.**

VANITY DESK, IN LINE WITH
THE ENTIRE COLLECTION, IS
COMPLETED BY A LACQUERED
GLASS TOP. THE BACK OF ENCLOSED
MIRROR IS BRILLIANTLY EQUIPPED
WITH CLOTHES-HANGERS.

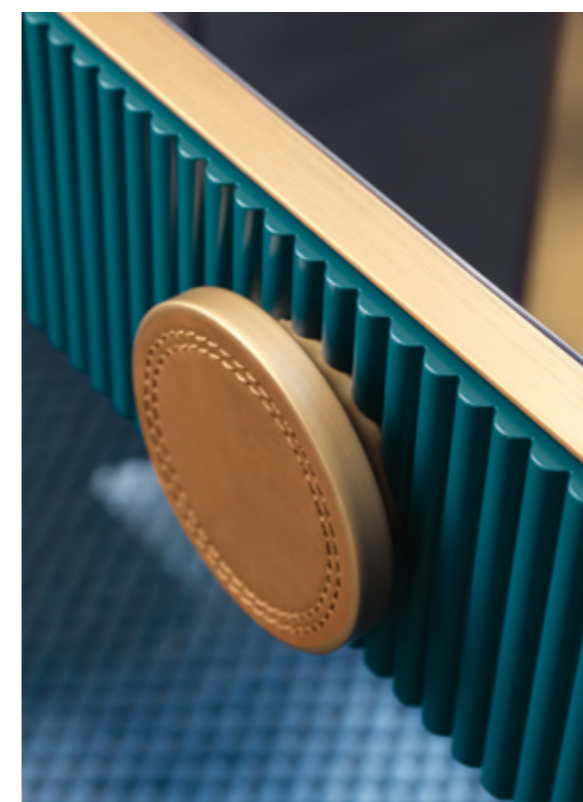



**RIPOSANTE E DISCRETA, LA TENUE
COLORAZIONE GRIGIO AGATA ADATTA
IL DESIGN DELLA COLLEZIONE ALLA
NOTTE, PUR SENZA TRADIRNE LE
FORME E I SEGNI PIÙ DISTINTIVI.**

RESTFUL AND DISCREET,
THE DELICATE AGATE GREY COLOUR SUITS
THE DESIGN OF THE COLLECTION
TO THE NIGHT, PRESERVING ITS SHAPES
AND ITS MOST DISTINGUISH MARKS.









Tavolini UP e MID, Piantana HERON
UP and MID Occasional tables, HERON Floor lamp





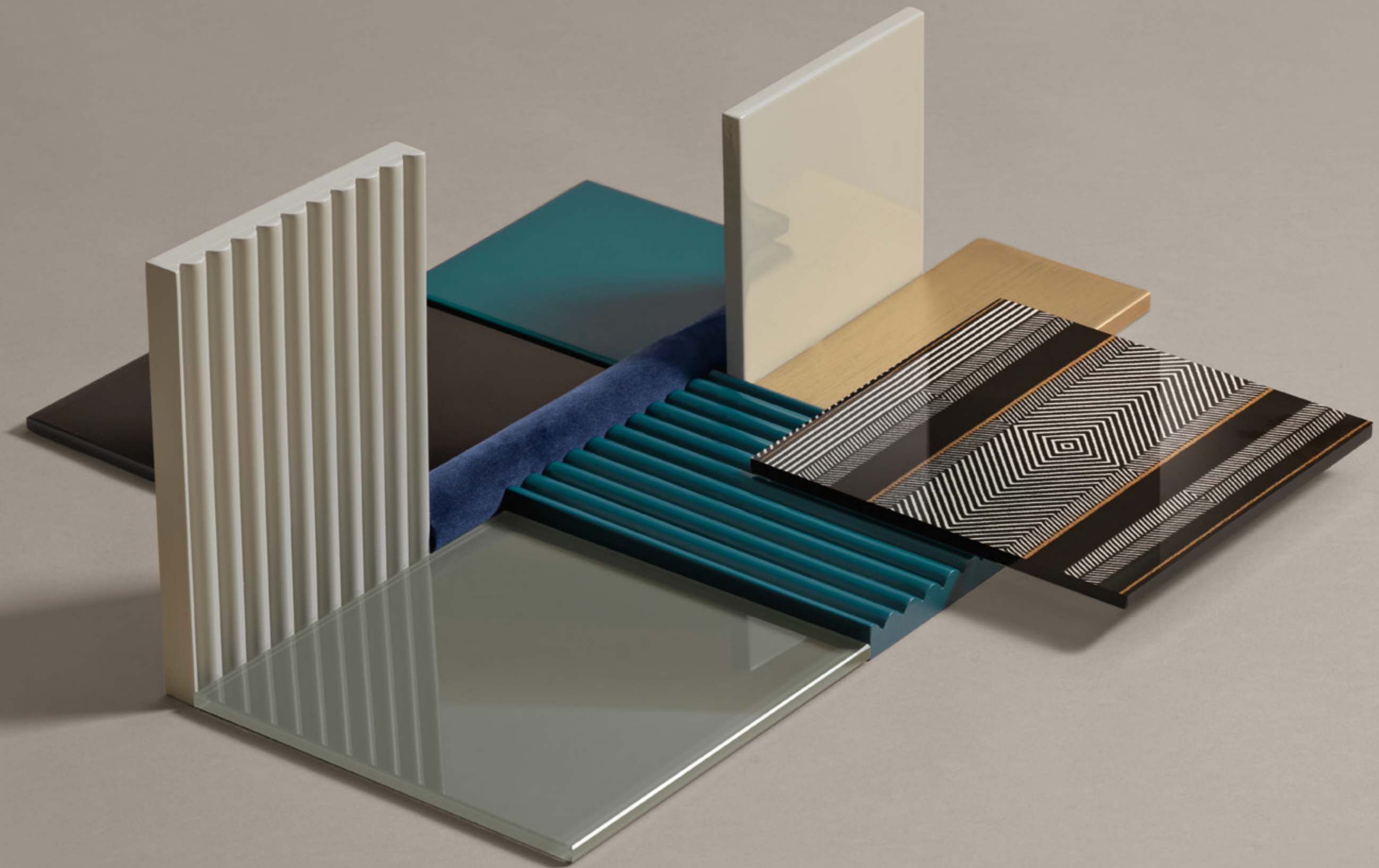

INFORMAZIONI TECNICHE DEI PRODOTTI

PRODUCTS TECHNICAL DATA

OVER N14

divano
sofa

MISURE DIMENSIONS
280x95xH 67 cm

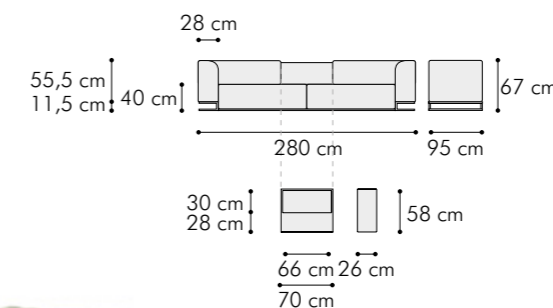

Divano 3 posti
Schienale equipaggiato con etagere impiallacciato EBONY, opaco
Tessuto: AZI-GL 501, cat. 1
Base: metallo finitura OTTONE

3 Seater sofa
Back equipped with etagere EBONY veneered, matt
Fabric: AZI-GL-501, cat.1
Base: metal BRASS finish

DISPONIBILE ANCHE NELLE MISURE:
ALSO AVAILABLE IN FOLLOWING SIZES:

200x95xH 67 CM
240x95xH 67 CM

Il divano può essere ordinato con schienale completamente imbottito, senza etagere Codice art. OVERALL - N14FB

The sofa is also available with back fully upholstered, without etagere
Code art. OVERALL - N14FB



WING N38

poltrona
armchair

MISURE DIMENSIONS
104x95xH 71 cm

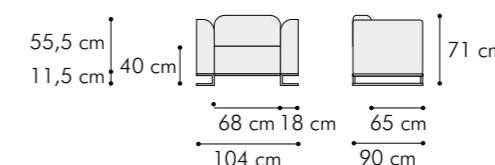

etagere
etagere

MISURE DIMENSIONS
70x26xH 58 cm

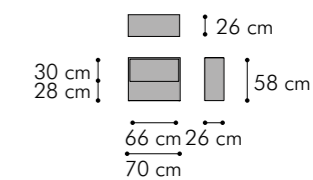

MODULO A dx/sx
ITEM A L/R

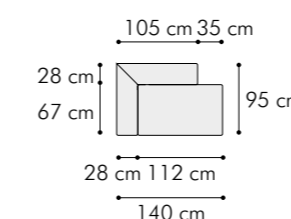

MODULO B dx/sx
ITEM B L/R

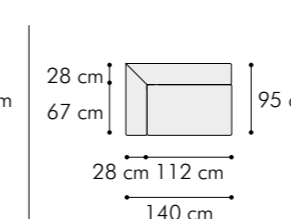

MODULO C dx/sx
ITEM C L/R

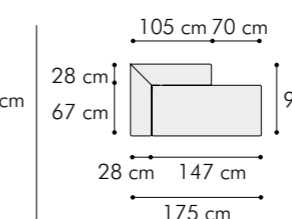

MODULO D dx/sx
ITEM D L/R

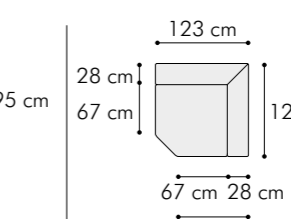

MODULO E
ITEM E

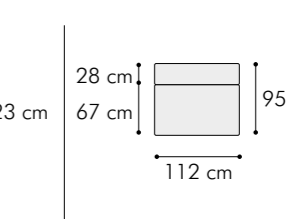

MODULO F1/F2
ITEM F1/F2

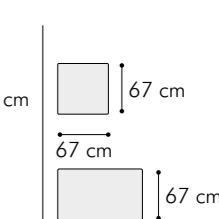

COMPOSIZIONI CONSIGLATE
SUGGESTED COMPOSITIONS

COMPOSIZIONE 1
COMPOSITION 1

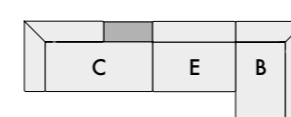

COMPOSIZIONE 2
COMPOSITION 2

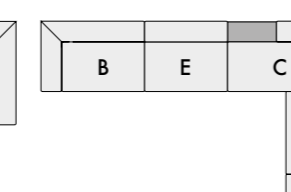

COMPOSIZIONE 3
COMPOSITION 3

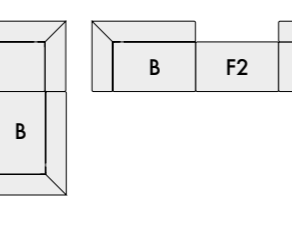

COMPOSIZIONE 4
COMPOSITION 4

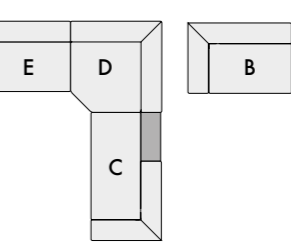

COMPOSIZIONE 5
COMPOSITION 5

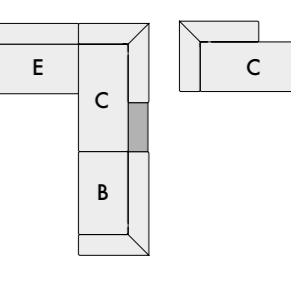

PAG.12-18

RODEO N26

divano
sofa

MISURE DIMENSIONS
250x100xH 66/88 cm

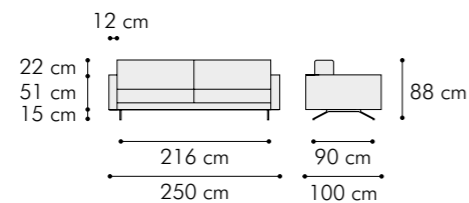

Divano 3 posti
Tessuto TAD-GL 16, cat.2
Gambe in metallo finitura TITANIO

3 Seater sofa
Fabric TAD-GL 16, cat.2
TITANIUM finish metal legs

DISPONIBILE ANCHE NELLE MISURE:
ALSO AVAILABLE IN FOLLOWING SIZES:

200x100xH 66/88 CM
300x100xH 66/88 CM



PAG.42-45

PRIZE N27

pouf
pouf

MISURE DIMENSIONS
66x66xH 42 cm

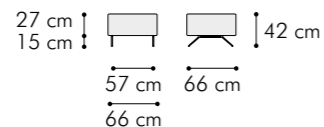

Pouf
Tessuto KAT-AL 05, cat.2
Gambe in metallo finitura TITANIO

Pouf
Fabric KAT-AL 05, cat.2
TITANIUM finish metal legs



PAG.34, 43

DIVA N28

poltrona
armchair

MISURE DIMENSIONS
98x88xH 66/88 cm

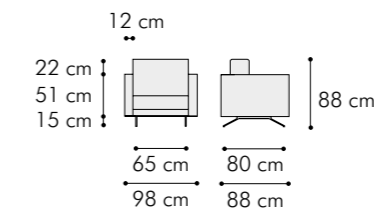

Poltrona
Tessuto AZI-GL 303, cat.1
Gambe in metallo finitura TITANIO

Armchair
Fabric AZI-GL 303, cat.1
TITANIUM finish metal legs



PAG.46-47

LOUNGE N06

mobile bar
bar unit

MISURE DIMENSIONS
108x58xH 170 cm

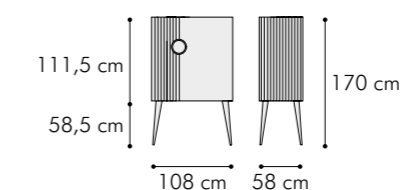

Mobile bar a 2 ante
Fianco/anta sinistri: canneté 7026 GRIGIO GRANITO, opaco
Fianco/anta destri: impiallacciati EBONY, opaco
Piano vetro laccato 7010 GRIGIO TENDA
con profilo finitura OTTONE
Gambe: 7026 GRIGIO GRANITO, brillante
Puntali finitura OTTONE
Maniglia finitura OTTONE
con inserto in cuoio COGNAC con impuntura a due aghi
Interno: 7038 GRIGIO AGATA, opaco
Equipaggiamento interno:
2 cassetti laterali apertura push-pull con fondino e copelle 11080
1 ripiano centrale estraibile push-pull con piano specchio
1 ripiano in legno - 2 ripiani in vetro fumé
1 porta-calici finitura OTTONE a 3 corsie
Schienale specchio a listelli
Illuminazione LED con sensore di apertura

Bar unit with 2 doors
Left side/door: canneté 7026 GRANITE GREY, matt
Right side/door: EBONY veneered, matt
Lacquered glass top 7010 TARPULIN GREY
with BRASS finish profile
Legs: 7026 GRANITE GREY, glossy
BRASS finish feet
BRASS finish handle with two-needle stitching COGNAC leather insert
Inside: 7038 AGATE GREY, matt
Inner equipment:
2 push-pull side drawers, inside bottom uph. eco-leather 11080
1 push-pull center serving shelf with mirror on top
1 wooden shelf - 2 smoke glass shelves
3 rails wine glasses BRASS holder
Mirror with strips on back
LED lights with opening sensor



PAG.12-13, 20-23

SHORT N09

tavolino
coffee table

MISURE DIMENSIONS
Ø90xH 31 cm

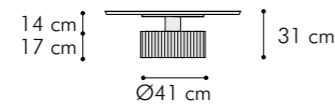

Tavolino
Piano Ø 90 cm, impiallacciato EBONY, opaco
con bisellatura inferiore
Cilindro finitura OTTONE
Base canneté 7026 GRIGIO GRANITO, opaco

Il piano è disponibile anche in marmo (N09-M)
o vetro stampato (N09-G)

Coffee table
Top Ø 90 cm, EBONY veneered, matt, bevelled edge
BRASS finish cylinder
Base with canneté wooden pattern 7026 GRANITE GREY, matt

Top is also available in marble (N09-M) or printed glass (N09-G)



PAG.12-15, 18-19, 26-28

UP N12

tavolino
occasional table

MISURE DIMENSIONS
Ø40xH 57 cm

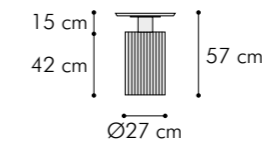

Tavolino
Piano Ø 40 cm, specchio fumé con bordo finitura OTTONE
Cilindro finitura OTTONE
Base canneté 7026 GRIGIO GRANITO, opaco

Il piano è disponibile anche impiallacciato (N12-W),
vetro stampato (N12-G) e marmo (N12-M)

Occasional table
Top Ø 40 cm, smoke mirror top, with BRASS finish profile
BRASS finish cylinder
Base with canneté wooden pattern 7026 GRANITE GREY, matt

Top is also available with veneer (N12-W), printed glass (N12-G)
or marble (N12-M)



PAG.12-13, 18-20, 28, 41-43, 104, 110-111

MID N10-M / MID N10-G

tavolino
occasional table

MISURE DIMENSIONS
Ø60xH 43 cm

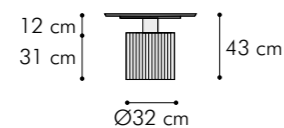

N10-M
Tavolino
Piano Ø 60 cm, marmo OCEAN BLACK opaco
con bisellatura inferiore
Cilindro finitura OTTONE
Base canneté 7026 GRIGIO GRANITO, opaco

Il piano è disponibile anche impiallacciato (N10-W)
o vetro stampato (N10-G)

N10-M
Occasional table
Top Ø 60 cm, OCEAN BLACK marble top, matt, bevelled edge
BRASS finish cylinder
Base with canneté wooden pattern 7026 GRANITE GREY, matt

Top is also available with veneer (N10-W) or printed glass (N10-G)

N10-G
Tavolino
Piano Ø 60 cm, vetro con stampa digitale BLACK-WOOL
Cilindro finitura OTTONE
Base canneté 7026 GRIGIO GRANITO, opaco

Il piano è disponibile anche impiallacciato (N10-W)
o marmo (N10-M)
Vedi pagina 147 per disegni di stampa alternativi

N10-G
Occasional table
Top Ø 60 cm, BLACK-WOOL digital printed glass top
BRASS finish cylinder
Base with canneté wooden pattern 7026 GRANITE GREY, matt

Top is also available with veneer (N10-W) or marble (N10-M)
See page 147 for alternative print patterns



PAG.12-15, 17-19, 41, 46, 110-111

SUNSET N39 / SUNRISE N40

tavolino
coffee table/occasional table

MISURE DIMENSIONS
150x70xH 45 cm
70x70xH 55 cm

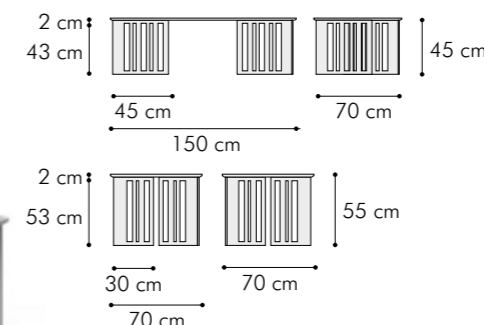

SUNSET N39
Tavolino
Piano 7010 GRIGIO TENDA, opaco
con inserto in vetro laccato 7010 GRIGIO TENDA
Profilo finitura TITANIO
Base in metallo finitura TITANIO

SUNSET N39
Coffee table
Top 7010 TARPULIN GREY, matt
with 7010 TARPULIN GREY lacquered glass insert
TITANIUM finish profile
TITANIUM finish metal base

SUNRISE N40
Tavolino
Piano marmo BIANCO CALACATTA
Base in metallo finitura OTTONE

Disponibile con altri tipi di marmo, vedi pagina 147

SUNRISE N40
Occasional table
WHITE CALACATTA marble top
BRASS finish metal base

Available with different marble tops, see page 147

I tavolini N39 e N40 sono disponibili con piano in marmo,
vetro laccato, impiallacciato EBONY

Tables N39 and N40 are also available with marble top,
lacquered glass top, EBONY veneered top



AROUND N13

consolle
console

MISURE DIMENSIONS
141x45xH 81 cm

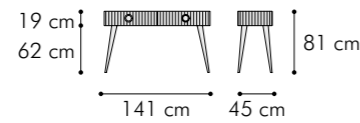

Consolle con 1 cassetto
7026 GRIGIO GRANITO, opaco
Piano vetro laccato 6005 VERDE MUSCHIO
profilo finitura OTTONE
Gambe: 7026 GRIGIO GRANITO, brillante
Puntali finitura OTTONE
Fondino cassetto in ecopelle 11080 con impuntura a due aghi
Maniglie finitura OTTONE
con inserto in cuoio COGNAC con impuntura a due aghi

Console table with 1 drawer
7026 GRANITE GREY, matt
Lacquered glass top 6005 MOSS GREEN
with BRASS finish profile
Legs: 7026 GRANITE GREY, glossy
BRASS finish feet
Inside bottom of drawer upholstered with eco-leather 11080
with two-needle stitching
BRASS finish handles
with two-needle stitching COGNAC leather insert



PAG.14-15, 24-25

WIDE N07

base per TV
TV unit

MISURE DIMENSIONS
222x57xH 51 cm

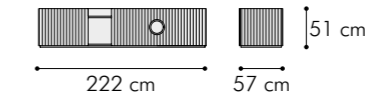

Base per TV a 3 ante, 4 vani
7026 GRIGIO GRANITO, opaco
Piano in vetro laccato 7010 GRIGIO TENDA
con profilo finitura OTTONE
Vano a giorno con ripiano regolabile in legno
1 ripiano regolabile in vetro fumé dentro anta centrale e destra
Maniglia finitura OTTONE
con inserto in cuoio COGNAC con impuntura a due aghi

TV unit with 3 doors, 4 spaces
7026 GRANITE GREY, matt
Lacquered glass top 7010 TARPULIN GREY
with BRASS finish profile
Open space with adjustable wooden shelf
1 adjustable smoke glass shelf behind central and right door
BRASS finish handle
with two-needle stitching COGNAC leather insert



PAG.26-31

CLEVER N08

libreria
equipped wall unit

MISURE DIMENSIONS
270x53xH 224 cm

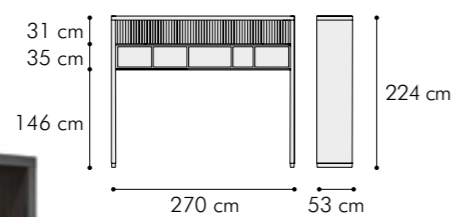

Libreria con 2 ripiani
Impiallacciata EBONY, opaco
Schienale dietro ripiano superiore con canneté
7026 GRIGIO GRANITO, opaco
Ripiano inferiore accessorizzato con divisori in metallo
finitura OTTONE, con fondo in vetri fumé
Illuminazione LED su ripiano inferiore

Equipped wall unit with 2 shelves
EBONY veneered, matt
Canneté 7026 GRANITE GREY, matt, on back of upper shelf
Lower shelf equipped with metal BRASS finish dividers,
bottom smoke glasses
LED light on lower shelf



PAG.26-29

STAGE N29 / FLAT N37

libreria componibile/mensola da terra
modular bookcase/floor standing shelf

h. 220

h. 260

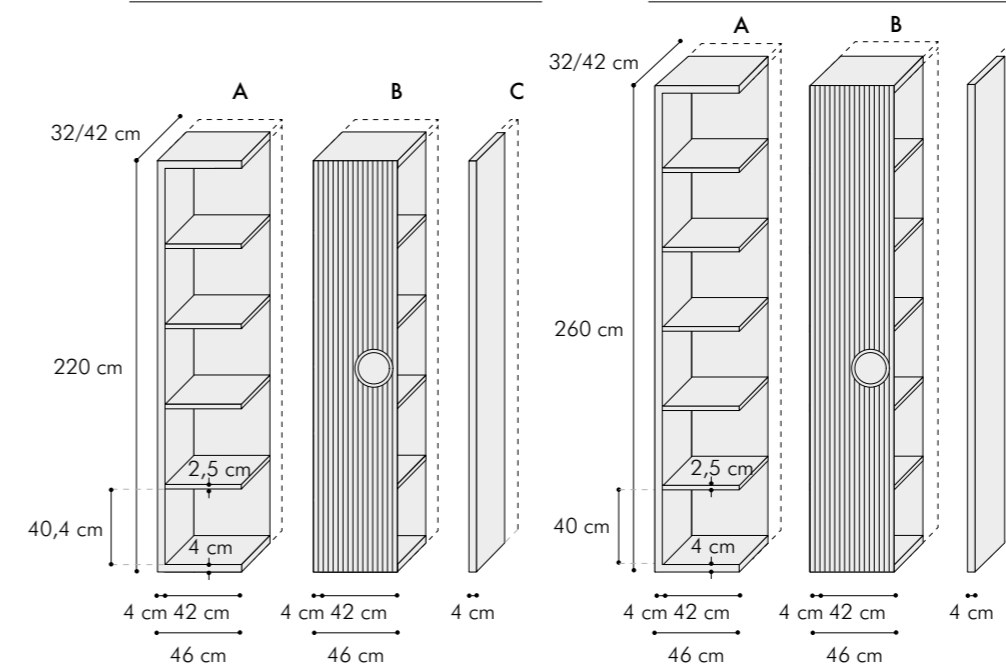

STAGE N29
Struttura 1013 BIANCO PERLA, opaco
Ante in canneté 1005 GIALLO MIELE, opaco
Maniglie finitura TITANIO
con inserto in vetro laccato 1005 GIALLO MIELE

STAGE N29
Structure 1013 OYSTER WHITE, matt
Doors with canneté wooden pattern 1005 HONEY YELLOW, matt
TITANIUM finish handles
with 1005 HONEY YELLOW glass lacquered insert

FLAT N37
Mensola da terra con pannello canneté e luce LED
7010 GRIGIO TENDA, opaco

FLAT N37
Floor standing shelf with canneté back panel and LED light
7010 TARPULIN GREY, matt

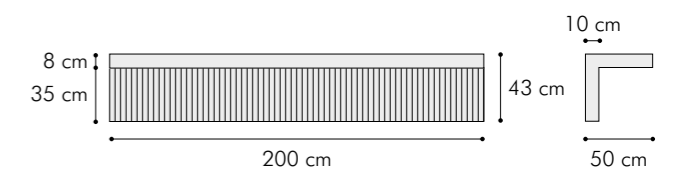

PAG.36-40

SURF N30

mensola
shelf

MISURE DIMENSIONS
140x26xH 5 cm

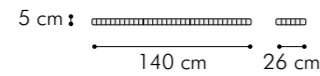

Mensola
7010 GRIGIO TENDA, opaco
Piano in vetro laccato 7010 GRIGIO TENDA
con profilo finitura TITANIO
Illuminazione LED posteriore

Shelf
7010 TARPULIN GREY, matt
Lacquered glass top 7010 TARPULIN GREY
with TITANIUM finish profile
LED light on the back

DISPONIBILE ANCHE NELLE MISURE:
ALSO AVAILABLE IN FOLLOWING SIZES:

110x26xH 5 cm



PAG.40-41

SMOKE N16

poltrona
armchair

MISURE DIMENSIONS
79x86xH 107 cm

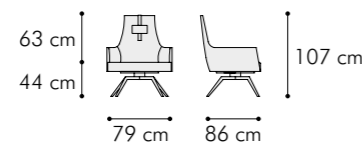

Poltrona
Base: metallo finitura OTTONE
Rivestimento: pelle DAK-DI 0229, cat. A
Poggiatesta: pelle DAK-DI 0229, cat. A
Cuscino poggiatesta non incluso (vedi pagina140)

Armchair
Base: metal BRASS finish
Upholstery: leather DAK-DI 0229, cat. A
Headrest: leather DAK-DI 0229, cat. A
Loin-rest cushion not included (see page 140)



PAG.22, 32-39

ROCK N03

tavolo piano marmo
marble top table

MISURE DIMENSIONS
230x120xH 78 cm

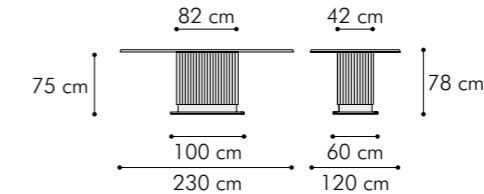

Tavolo da pranzo
con piano marmo OROBICO ROSSO, opaco
Piedistallo in canneté 7026 GRIGIO GRANITO, opaco
Piastra in metallo finitura OTTONE

Disponibile con altri tipi di marmo, vedi pagina 147

Dining table
with OROBIC RED marble top, matt
Base with canneté 7026 GRANITE GREY, matt
BRASS finish metal platform.

Available with different marble tops, see page 147



PAG.54-59

FUTURE N04

tavolo piano vetro con stampa digitale
digital printed glass top table

MISURE DIMENSIONS
230x120xH 78 cm

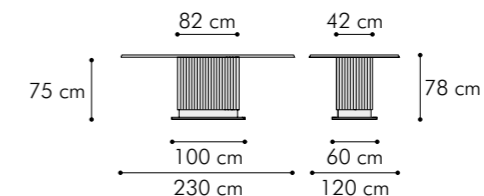

Tavolo da pranzo
con piano in vetro con stampa digitale BLUE SKY
Piedistallo in canneté 7026 GRIGIO GRANITO, opaco
Piastra in metallo finitura OTTONE

Piano in vetro stampato disponibile in altri colori, vedi pagina 147

Dining table
with high definition digital printed glass top, BLUE SKY
Base with canneté 7026 GRANITE GREY, matt
BRASS finish metal platform

Digital printed glass top available in different colours, see page 147

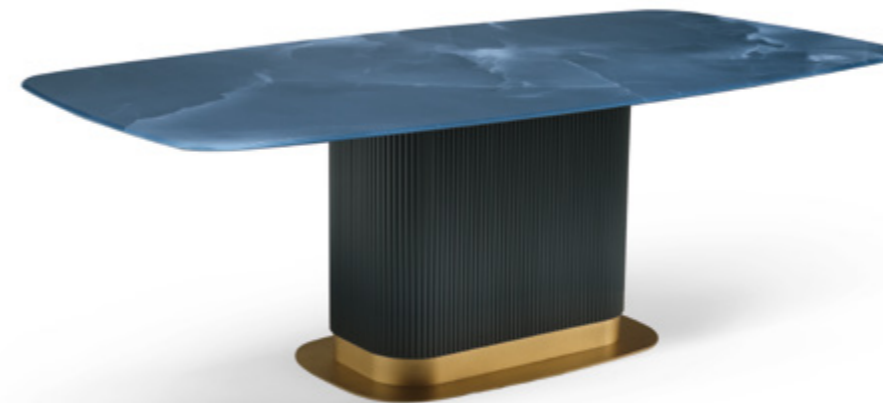

PAG.60-63

CIRCLE N31

tavolo con piano marmo
marble top table

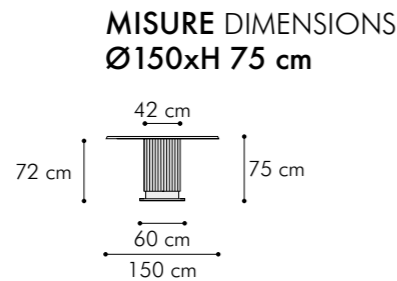

Tavolo da pranzo
con piano marmo OMBRA DI CARAVAGGIO
Piedistallo in canneté 8004 MARRONE RAME, opaco
Piastra in metallo finitura OTTONE

Disponibile con altri tipi di marmo, vedi pagina 147

Dining table
with OMBRA DI CARAVAGGIO marble top
Base with canneté 8004 COPPER BROWN, matt
BRASS finish metal platform

Available with different marble tops, see page 147

DISPONIBILE ANCHE NELLE MISURE:
ALSO AVAILABLE IN FOLLOWING SIZES:

Ø130xH 75 cm
Ø170xH 75 cm

PAG.70-73, 78

DARK N35

tavolo con piano impiallacciato ebano
ebony veneered top table

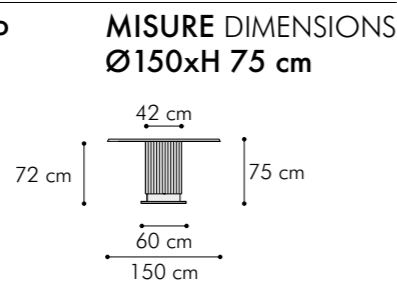

Tavolo da pranzo
con piano impiallacciato EBONY, opaco
con bisellatura inferiore
Piedistallo in canneté 8004 MARRONE RAME, opaco
Piastra in metallo finitura OTTONE

Dining table
with EBONY veneered top, matt, bevelled edge
Base with canneté 8004 COPPER BROWN, matt
BRASS finish metal platform

DISPONIBILE ANCHE NELLE MISURE:
ALSO AVAILABLE IN FOLLOWING SIZES:

Ø130xH 75 cm
Ø170xH 75 cm

PAG.76-77, 79

TWIST N32-GL / TWIST N32-GP

piano girevole
lazy susan

MISURE DIMENSIONS
Ø60xH 2,3 cm

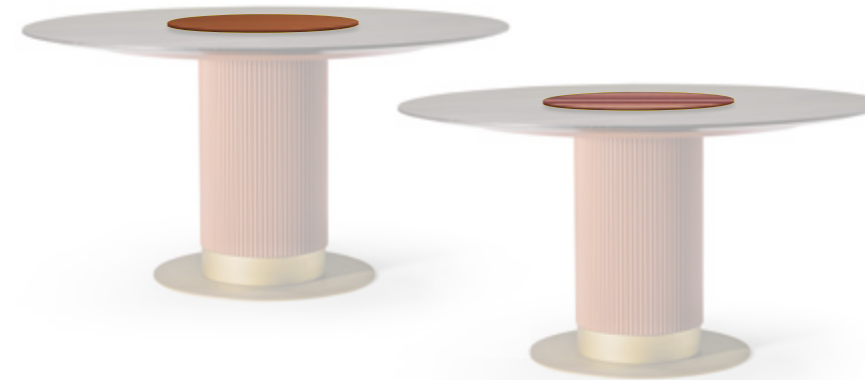
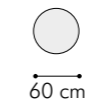

N32-GL
Piano girevole in vetro laccato 8004 MARRONE RAME
Meccanismo girevole a sfere in alluminio

N32-GL
8004 COPPER BROWN lacquered glass lazy susan
Aluminum ball swivel mechanism

N32-GP
Piano girevole in vetro con stampa digitale RED-WOOL
Meccanismo girevole a sfere in alluminio

Piano in vetro stampato disponibile in altri colori, vedi pagina 147

N32-GP
RED-WOOL digital printed glass lazy susan
Aluminum ball swivel mechanism

Digital printed glass top available in different colours, see page 147

PAG.78-79

EMBRACE N05

sedia
chair

MISURE DIMENSIONS
63x63xH 86 cm

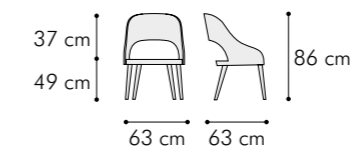

Sedia
Rivestimento esterno: pelle DAK-DI 0229, cat. A
Rivestimento interno: tessuto AZI-GL 803, cat.1
Fondo/gambe: 7026 GRIGIO GRANITO, brillante
Puntali in metallo finitura OTTONE

Chair
Outside upholstery: Leather DAK-DI 0229, cat. A
Inside upholstery: fabric AZI-GL 803, cat.1
Bottom/legs: 7026 GRANITE GREY, glossy
BRASS finish metal tips

PAG.54-63, 70-74, 82-84

KISS N34

sedia
chair

MISURE DIMENSIONS
52x66xH 85 cm

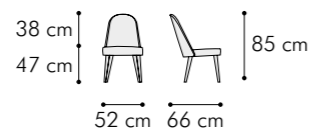

Sedia
Tessuto TAD-GL 12, cat.2
Gambe: 8004 MARRONE RAME, opaco
Puntali in metallo finitura OTTONE

Chair
Fabric TAD-GL 12, cat.2
Legs: 8004 COPPER BROWN, matt
BRASS finish metal tips



PAG.80-81

SPY N33

sedia
chair

MISURE DIMENSIONS
52x66xH 85 cm

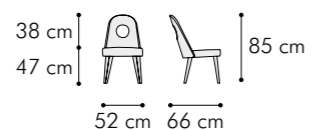

Sedia
Tessuto AZI-GL 303, cat.1
Gambe: 8004 MARRONE RAME, opaco
Anello decorativo posteriore in metallo, finitura OTTONE
Puntali in metallo finitura OTTONE

Chair
Fabric AZI-GL 303, cat.1
Legs: 8004 COPPER BROWN, matt
BRASS finish metal ring on the back
BRASS finish metal tips



PAG.76-78, 81

FACE N01

credenza
sideboard

MISURE DIMENSIONS
220x50xH 89 cm

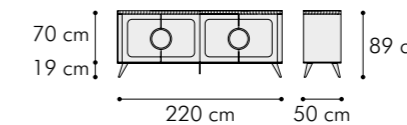

Credenza 4 porte, 2 vani
7026 GRIGIO GRANITO, opaco
Piano in vetro laccato 5004 BLU NERASTRO
con profilo finitura OTTONE
Gambe 7026 GRIGIO GRANITO, brillante
Puntali finitura OTTONE
Maniglie finitura OTTONE
con inserto in cuoio COGNAC con impuntura a due aghi
Interno: 8004 MARRONE RAME, opaco
1 ripiano regolabile in vetro fumé dentro ciascun vano
Illuminazione LED con sensore di apertura

4 doors sideboard, 2 spaces
7026 GRANITE GREY, matt
Lacquered glass top 5004 BLACK BLUE
with BRASS finish profile
Legs 7026 GRANITE GREY, glossy
BRASS finish feet
BRASS finish handles
with two-needle stitching COGNAC leather insert
Inside: 8004 COPPER BROWN, matt
1 adjustable smoke glass shelf behind each space
LED light with opening sensor

PAG.60-67

SMILE N25

credenza
sideboard

MISURE DIMENSIONS
119x50xH 89 cm

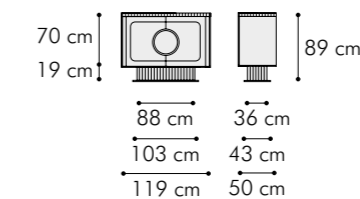

Credenza 2 porte
8004 MARRONE RAME, opaco
Piano in vetro laccato 8004 MARRONE RAME
con profilo finitura OTTONE
Piedistallo in canneté 6005 VERDE MUSCHIO, opaco
Piastra in metallo finitura OTTONE
Maniglia finitura OTTONE
con inserto in vetro laccato 8004 MARRONE RAME
Interno: 8004 MARRONE RAME, opaco
1 ripiano regolabile in vetro fumé
Illuminazione LED con sensore di apertura

2 doors sideboard
8004 COPPER BROWN, matt
Lacquered glass top 8004 COPPER BROWN
with BRASS finish profile
Base with canneté 6005 MOSS GREEN, matt
BRASS finish metal platform
BRASS finish handle
with 8004 COPPER BROWN glass lacquered insert
Inside: 8004 COPPER BROWN, matt
1 adjustable smoke glass shelf
LED light with opening sensor

PAG.70-71, 74-75

SMART N02

vetrina
vitrine



MISURE DIMENSIONS
135x43xH 168 cm

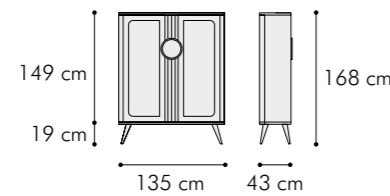

Vetrina a 2 ante
7026 GRIGIO GRANITO, opaco
Gambe 7026 GRIGIO GRANITO, brillante
Puntali finitura OTTONE
Maniglie finitura OTTONE
con inserto in cuoio COGNAC con impuntura a due aghi
Interno: schienale rivestito in ecopelle 11080
con impuntura a due aghi
2 ripiani regolabili in vetro fumé
Illuminazione LED con sensore di apertura

2 doors vitrine
7026 GRANITE GREY, matt
Legs 7026 GRANITE GREY, glossy
BRASS finish feet
BRASS finish handles
with two-needle stitching COGNAC leather insert
Inside: back upholstered with eco-leather 11080
with two-needle stitching
2 adjustable smoke glass shelves
LED light with opening sensor

PAG.68-72

AWAY N18

comodino
bedside table

MISURE DIMENSIONS
66x45xH 58 cm

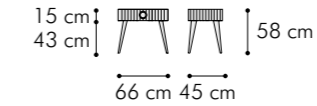

Comodino con 1 cassetto
7038 GRIGIO AGATA, opaco
Piano vetro laccato 7010 GRIGIO TENDA
con profilo finitura OTTONE
Gambe: 7038 GRIGIO AGATA, brillante
Puntali finitura OTTONE
Fondino cassetto in ecopelle 11080 con impuntura a due aghi
Maniglia finitura OTTONE
con inserto in cuoio COGNAC con impuntura a due aghi

Bedside table with 1 drawer
7038 AGATE GREY, matt
Lacquered glass top 7010 TARPULIN GREY
with BRASS finish profile
Legs 7038 AGATE GREY, glossy
BRASS finish feet
Inside bottom of drawer upholstered with eco-leather 11080
with two-needle stitching
BRASS finish handle
with two-needle stitching COGNAC leather insert

PAG.92-95,102-103

BOND N17

letto
bed

MISURE DIMENSIONS
216x221xH 30/151 cm

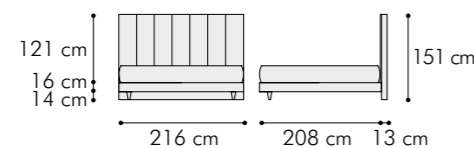

Letto imbottito
Testata letto con inserto laterale in canneté
7038 GRIGIO AGATA, opaco e profilo finitura OTTONE
Gambe: 7038 GRIGIO AGATA, brillante
Puntali finitura OTTONE
Rivestimento: Nabuk MON-DI 0855, cat. B
Giroletto con supporti angolari per rete in metallo
Per rete/materasso misura 200x200 cm
Disponibile su richiesta per qualsiasi misura di rete/materasso

Rete, materasso e coordinato letto sono esclusi

Upholstered bed
Headboard with side canneté wooden pattern insert
7038 AGATE GREY, matt and BRASS finish profile
Legs: 7038 AGATE GREY, glossy
BRASS finish feet
Covering: Nubuck MON-DI 0855, cat. B
Bedbox with corner metal supports for slat
For slat/mattress size 200x200 cm
Available upon request for any size of slat/mattress

Slat, mattress, bed linen are not included

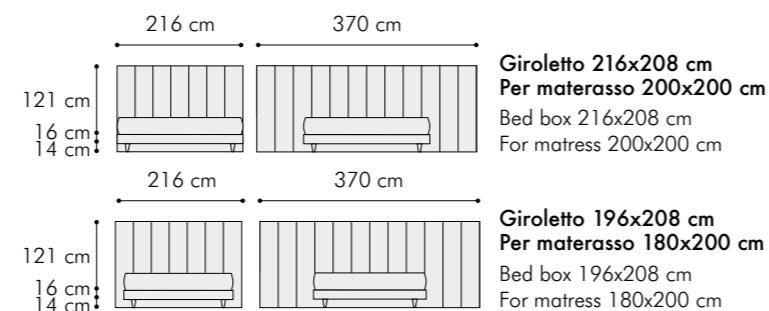

Giroletto 216x208 cm
Per materasso 200x200 cm
Bed box 216x208 cm
For mattress 200x200 cm

Giroletto 196x208 cm
Per materasso 180x200 cm
Bed box 196x208 cm
For mattress 180x200 cm



PAG.92-95, 100-103

SECRET N36

comodino
bedside table

MISURE DIMENSIONS
66x45xH 58 cm

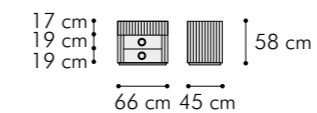

Comodino con 3 cassetti
7038 GRIGIO AGATA, opaco
Piano vetro laccato 6005 VERDE MUSCHIO
con profilo finitura OTTONE
Base finitura OTTONE
Maniglie finitura OTTONE
con inserto in vetro laccato 6005 VERDE MUSCHIO
Fondini cassetti in ecopelle 11080 con impuntura a due aghi

Bedside table with 3 drawers
7038 AGATE GREY, matt
Lacquered glass top 6005 MOSS GREEN
with BRASS finish profile
BRASS finish base
BRASS finish handles with 6005 MOSS GREEN lacquered glass
Inside bottom of drawers upholstered with eco-leather 11080
with two-needle stitching

PAG.112-113

FANCY N21

toilette con specchio
vanity desk with built-in mirror

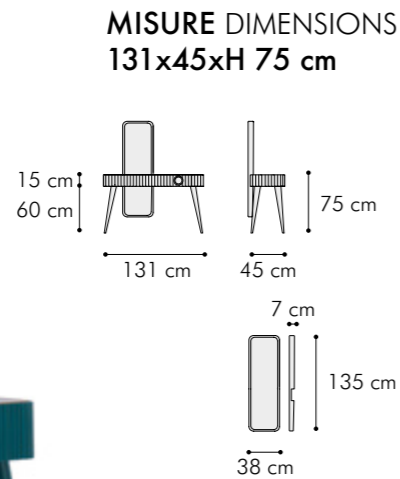

Toilette con specchio incorporato
Laccato 5020 BLU OCEANO, opaco
Piano in vetro laccato 5004 BLU NERASTRO
con profilo finitura OTTONE
Gambe 5020 BLU OCEANO, brillante, puntali finitura OTTONE
1 cassetto lato destro, con fondino ecopelle 11080
con impuntura a due aghi
Maniglia finitura OTTONE
con inserto in cuoio COGNAC con impuntura a due aghi
Cornice specchio finitura OTTONE, retro rivestito in ecopelle 11080
con impuntura a due aghi e 2 ganci attaccapanni in OTTONE

Vanity desk with built-in mirror
5020 OCEAN BLUE, matt
Lacquered glass top 5004 BLACK BLUE
with BRASS finish profile
Legs 5020 OCEAN BLUE, glossy, BRASS finish feet
1 right drawer with inside bottom eco-leather 11080
with two-needle stitching
BRASS finish handle
with two-needle stitching COGNAC leather insert
Built-in mirror with BRASS finish frame, back upholstered
with eco-leather 11080 with two-needle stitching
and 2 BRASS clothes-hangers

PAG.92-94, 98-101

GAZE N20

specchio per comò
mirror for chest of drawers



MISURE DIMENSIONS
80x5xH 90 cm

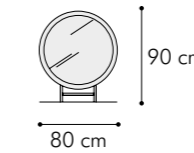

Specchio per comò
Metallo finitura OTTONE

Può essere fissato in qualsiasi punto dello schienale del comò

Mirror for chest of drawers
Metal BRASS finish

The mirror can be fixed in any position of back of chest of drawers

PAG.102, 104-106

DOUBLE N19

comò
chest of drawers

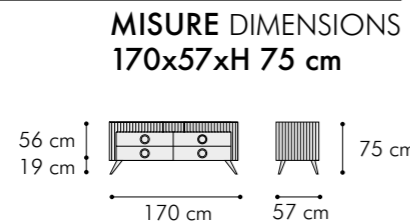
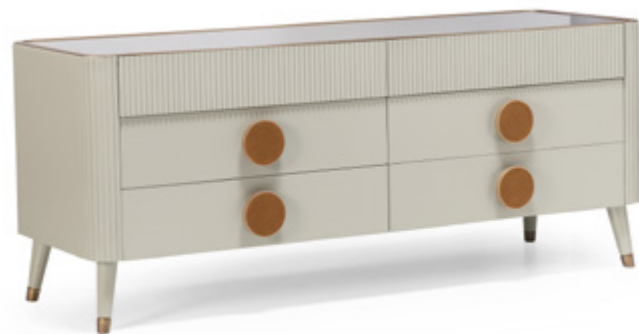

Comò con 6 cassetti
7038 GRIGIO AGATA, opaco
Piano vetro laccato 7010 GRIGIO TENDA
con profilo finitura OTTONE
Gambe: 7038 GRIGIO AGATA, brillante
Puntali finitura OTTONE
Cassetti superiori con apertura push-pull
Fondini cassetti in ecopelle 11080 con impuntura a due aghi
Maniglie finitura OTTONE
con inserto in cuoio COGNAC con impuntura a due aghi

Chest with 6 drawers
7038 AGATE GREY, matt
Lacquered glass top 7010 TARPAULIN GREY
with BRASS finish profile
Legs: 7038 AGATE GREY, glossy
BRASS finish feet
Upper drawers with push-pull opening
Inside bottom of drawers upholstered with eco-leather 11080
with two-needle stitching
BRASS finish handles
with two-needle stitching COGNAC leather insert

PAG.102, 104-109

BOUNCE N22

panchetta
bench



MISURE DIMENSIONS
153x58xH 53 cm

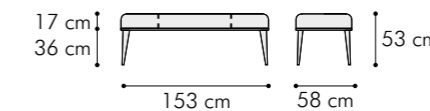

Panchetta
Rivestimento: pelle DAK-DI 0229, cat. A con impunture a due aghi
Fondo finitura OTTONE
Gambe: 7026 GRIGIO GRANITO, brillante
Puntali finitura OTTONE

Bench
Leather DAK-DI 0229, cat. A with two-needle stitching
Bottom BRASS finish
Legs: 7026 GRANITE GREY, glossy
BRASS finish feet

PAG.92-93, 96-97

INFINITY N24-300 / N24-200

armadio
wardrobe

MISURE DIMENSIONS
300x60xH 250 cm
200x60xH 250 cm

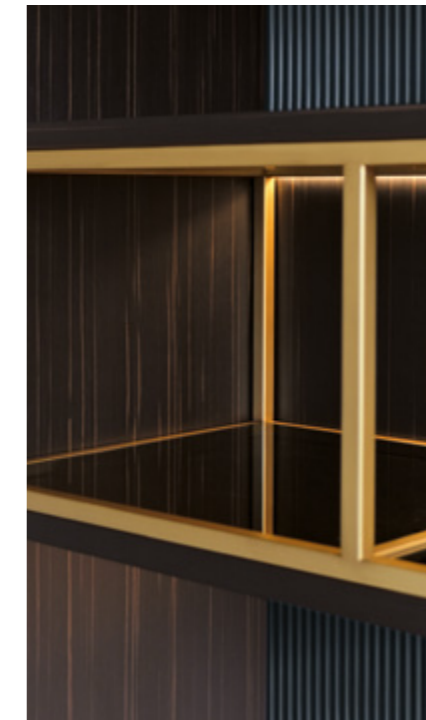
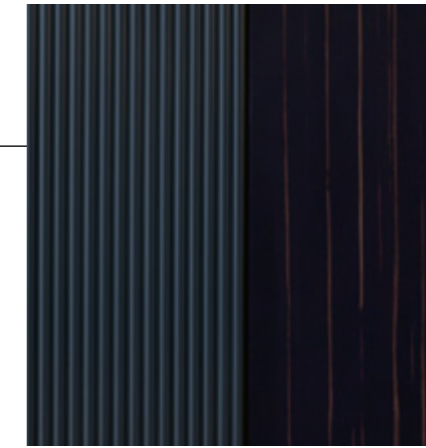
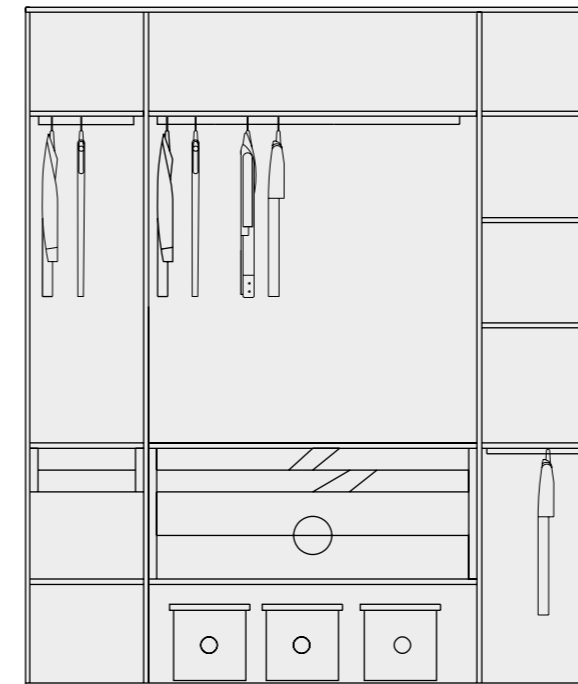
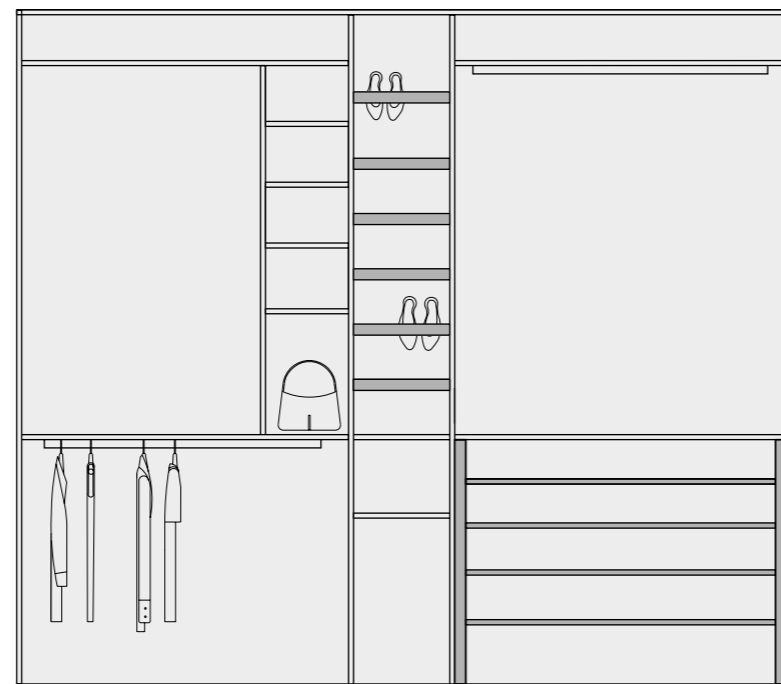
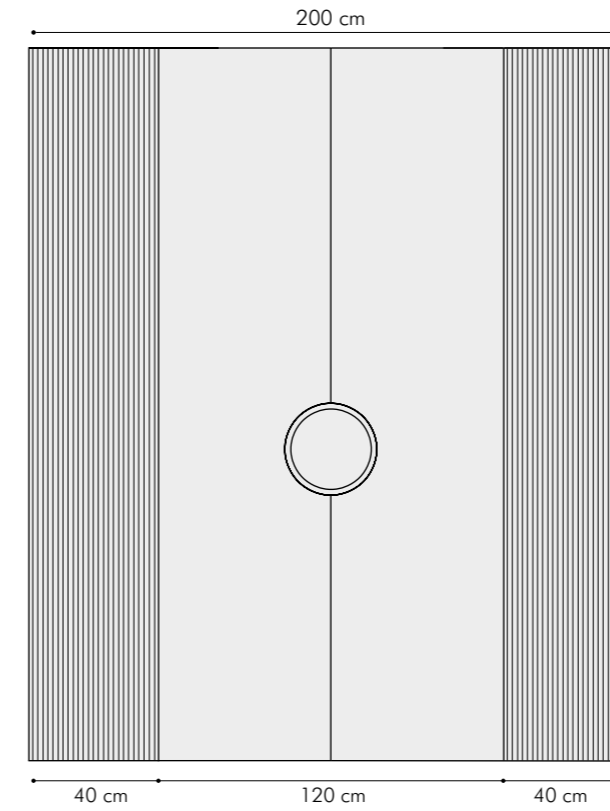
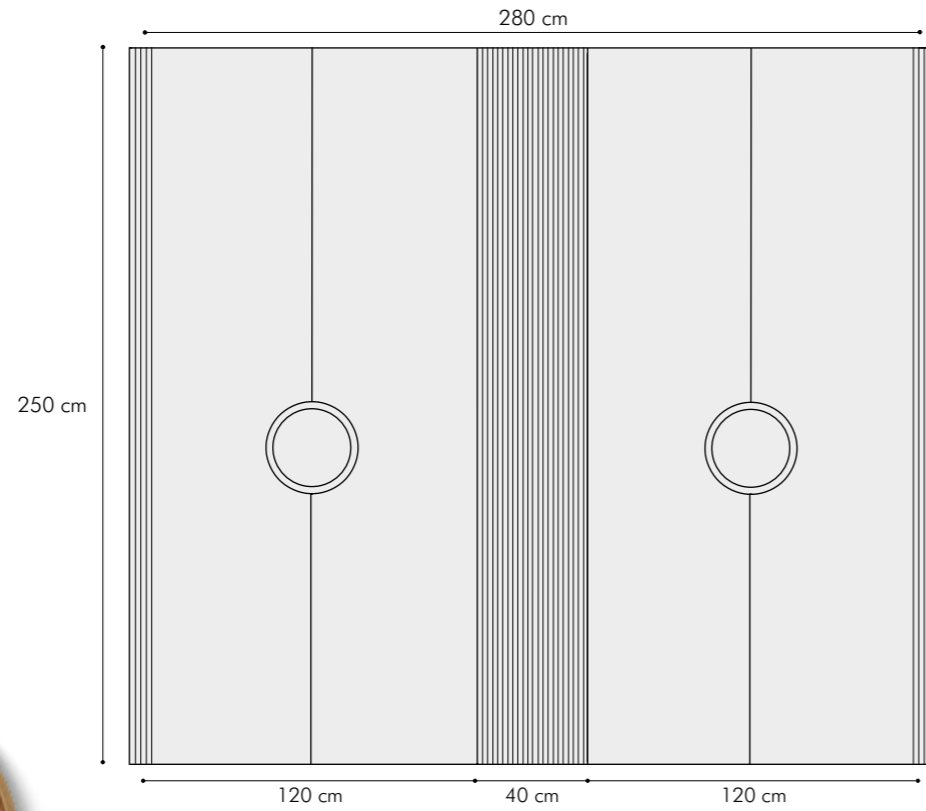
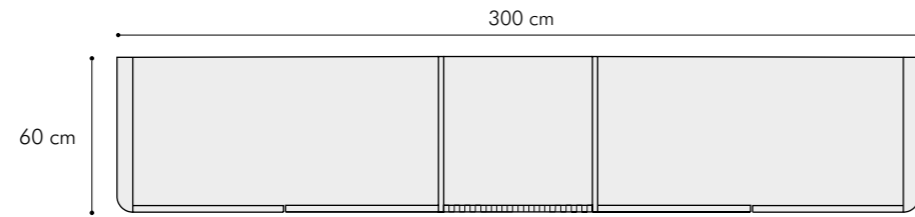

Armadio con ante a battente
Disponibile in tutte le finiture laccato RAL opaco o impiallacciato opaco
Fondini cassetti in ecopelle o laccati
Frontali cassetti in vetro fumé
Illuminazione a LED
Maniglie in finitura OTTONE/TITANIO con inserti in cuoio oppure vetro laccato
Ripiani in vetro fumé
Su richiesta i ripiani possono avere telaio in metallo lucidato OTTONE/TITANIO

Wardrobe
Available in any matt RAL lacquer or matt veneer
Inside bottom of drawers upholstered with eco leather or lacquered
Front of drawers with smoke glasses
LED lights with opening sensor
Handles in BRASS/TITANIUM finish with leather or lacquered glass inserts
Smoke glass shelves
Upon request, glass shelves may have a metal frame BRASS/TITANIUM finish



EASY N23

pouf
pouf

MISURE DIMENSIONS
Ø43xH 46 cm

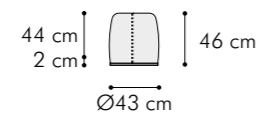

Pouf Ø 43 cm
Rivestimento: Nabuk MON-DI 0855, cat. B
Base: metallo finitura OTTONE

Pouf Ø 43 cm
Upholstery: Nubuck MON-DI 0855, cat. B
Base: metal BRASS finish



PAG.14, 24-27, 60-64, 68, 92-93, 98-107, 112

SWAN NL50

lampada da appoggio integrata
built-in table lamp

MISURE DIMENSIONS
14x18xH 67 cm

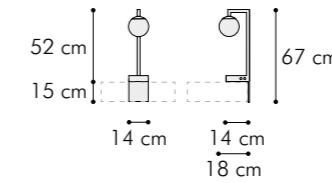

Lampada da appoggio integrata
Metallo finitura OTTONE
Sfera in vetro bianco
Accensione touch

Built-in table lamp
Metal BRASS finish
White glass sphere
Touch button



PAG.92-95

COLIBRÌ NL51

lampada da appoggio
table lamp

MISURE DIMENSIONS
14x18xH 52 cm

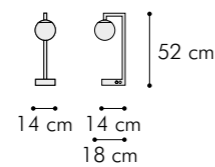

Lampada da appoggio
Metallo finitura OTTONE
Sfera in vetro bianco
Porta USB
Accensione con interruttore

Table lamp
Metal BRASS finish
White glass sphere
USB socket
Switch on button



PAG.12-15, 24-25, 70-71, 74, 102-103

FLAMINGO NL52

piantana
floor lamp

MISURE DIMENSIONS
25x25xH 142 cm

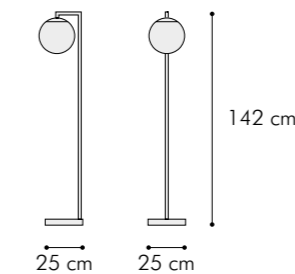

Piantana con base quadrata
Metallo finitura OTTONE
Sfera in vetro bianco

Floor lamp with square base
Metal BRASS finish
White glass sphere



PAG.12-14, 18-22, 28, 32, 34-35, 42-43, 46, 54-55, 68-72, 76-78, 82-85, 92-94, 98-102

HERON NL53

piantana
floor lamp



MISURE DIMENSIONS
Ø34,5xH 145 cm

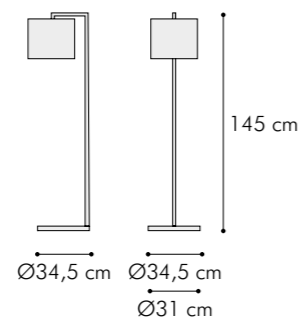

Piantana con base rotonda
Metallo finitura OTTONE
Paralume in tessuto grigio perla

Floor lamp with round base
Metal BRASS finish
Pearl grey fabric shade

PAG.16-17, 62, 64, 104-107, 110-112

SEAGULL NL54

lampadario
chandelier



MISURE DIMENSIONS
Ø60xH 120 cm

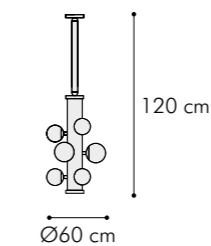

Lampadario con tubolare in metallo
finitura OTTONE
Cintura di sospensione in cuoio
9 sfere in vetro bianco

Chandelier with metal BRASS finish tube
Leather suspension belt
9 white glass spheres

PAG.54-57

NEST NL55

lampadario
chandelier



MISURE DIMENSIONS
Ø38xH 20 cm

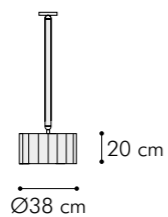

Lampadario con cristalli blu
Cintura di sospensione in cuoio

Chandelier with blue crystals
Leather suspension belt

PAG.60-61

EAGLE NL56

lampada da appoggio
table lamp



MISURE DIMENSIONS
Ø30xH 35 cm

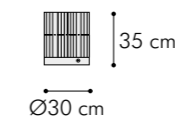

Lampada da appoggio con cristalli blu
Base in cuoio con presa USB

Table lamp with blue crystals
Leather base with USB socket

PAG.26-28, 36, 38-41, 60-62, 64, 67

TREASURE NA40

scatola
box

MISURE DIMENSIONS
25x25xH 13 cm

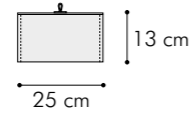

Scatola con coperchio
Cuoio COGNAC

Box with lid
Leather COGNAC



PAG.100

SOFT 30 NA42

cuscinò
cushion

MISURE DIMENSIONS
50x30 cm

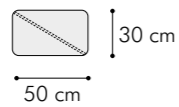

Cuscino
Rivestimento: pelle DAK-DI 0229, cat. A
con impuntura a due aghi

Cushion
Covering: DAK-DI 0229, cat.A
with two-needle stitching



PAG.12-17, 22, 34-39, 102

SOFT 65 NA41

cuscinò
cushion

MISURE DIMENSIONS
65x65 cm

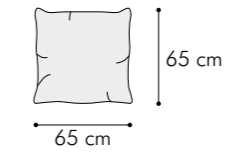

Cuscino
Rivestimento: CIR-AL 03, cat. 3

Cushion
Covering: CIR-AL 03, cat. 3



PAG.16-18, 42-43

SOFT 50 NA43

cuscinò
cushion

MISURE DIMENSIONS
50x50 cm

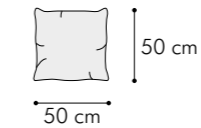

Cuscino
Rivestimento: GAR-AL 04, cat. 2

Cushion
Covering: GAR-AL 04, cat. 2



PAG.16-18, 46, 100

TESSUTI E FINITURE

FABRICS AND FINISHES

PELLE . LEATHER cat.A



DAK-DI 0229

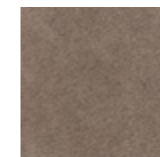

DAK-DI 0311

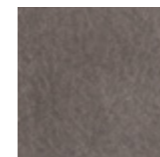

DAK-DI 0855

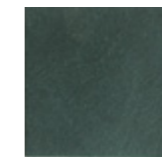

DAK-DI 0681

NABUK . NUBUCK cat.B



MON-DI 0855

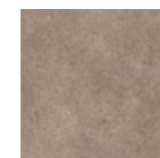

MON-DI 06048



MON-DI 0854

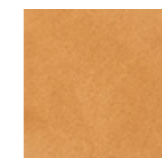

MON-DI 03403

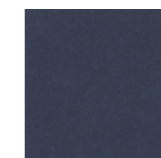

MON-DI 07120

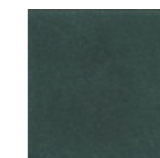

MON-DI 06099

TESSUTI . FABRICS

AZI-GL cat.1



AZI-GL 803



MIN-AL cat. 2



MIN-AL 06

BAR-MR-GL cat.2

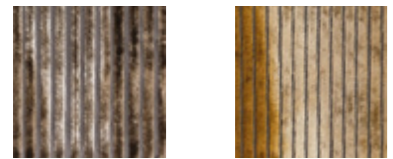

BAR-MR-GL 501

BAR-MR-GL 502

KAT-AL cat. 2



KAT-AL 01

KAT-AL 09

KAT-AL 05

BAR-GL cat. 2



BAR-GL 01

BAR-GL 04

BAR-GL 08

TAD-GL cat. 2

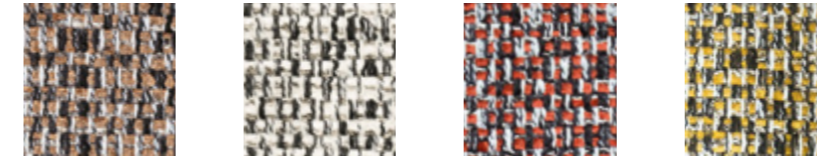

TAD-GL 13

TAD-GL 16

TAD-GL 12

TAD-GL 01

RUSH-GL cat. 1

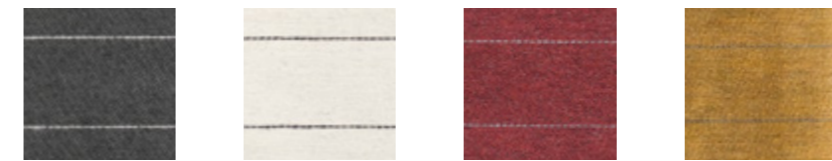

RUSH-GL 401/A

RUSH-GL 401/B

RUSH-GL 407/A

RUSH-GL 406/A

BAN-GL cat. 2



BAN-GL 24

BAN-GL 01

BAN-GL 02

BAN-GL 08

BAN-GL 05

BAN-GL 25

PIP-GL cat. 1

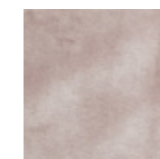

PIP-GL 24

ECOPELLE - ECO-LEATHER*



11080

10013

* Per interno cassetti/schienali
For inside bottom of drawers/back panels

MANIGLIE . HANDLES Ø20 cm - Ø12 cm

CUOIO . LEATHER



COGNAC



VETRO LACCATO . LACQUERED GLASS

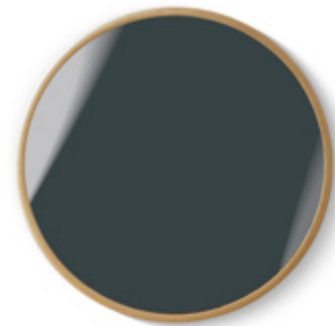

7026 GRANITE GREY



VETRO STAMPA DIGITALE . HIGH DEFINITION DIGITAL PRINTED GLASS

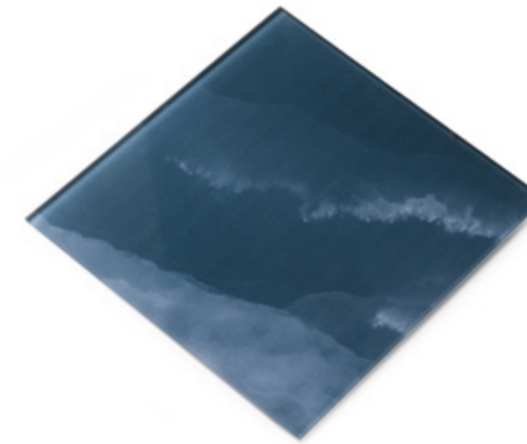

BLUE-SKY



MARMI . MARBLES*



OROBIC RED-MATT



* Disponibili in finitura lucida e opaca
Available in glossy and matt finish

LACCATI . LACQUERED*

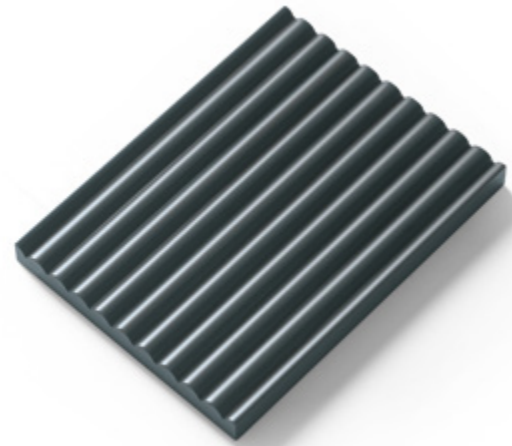

7026 GRANITE GREY



* Disponibili in finitura lucida e opaca
Available in glossy and matt finish

METALLI . METALS



OTTONE
BRASS

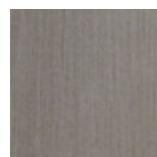

TITANIO
TITANIUM

ESSENZE . WOOD VENEER



EBONY-MATT



ZINGANA

^{IT} Scappini & C srl si riserva in qualsiasi momento la facoltà di apportare tutte le modifiche necessarie al miglioramento funzionale e qualitativo dei propri prodotti. Per ogni aspetto tecnico e dimensionale fare riferimento ai listini aziendali e relativi aggiornamenti. I colori e i materiali riprodotti nelle immagini stampate hanno un valore indicativo. Scappini & C srl declina ogni responsabilità derivante da eventuali inesattezze di stampa e/o da errori sulle caratteristiche dei prodotti forniti.

^{EN} In line with its policy of improving product function and quality, Scappini & C srl reserves the right to make any necessary changes at any time. For information of a technical and dimensional nature, refer to the company price lists and relevant updates. The colours and materials reproduced in the images printed herein are given as an approximate guide only. Scappini & C srl does not accept any responsibility for misprints and/or mistakes in describing the characteristics of the products supplied.

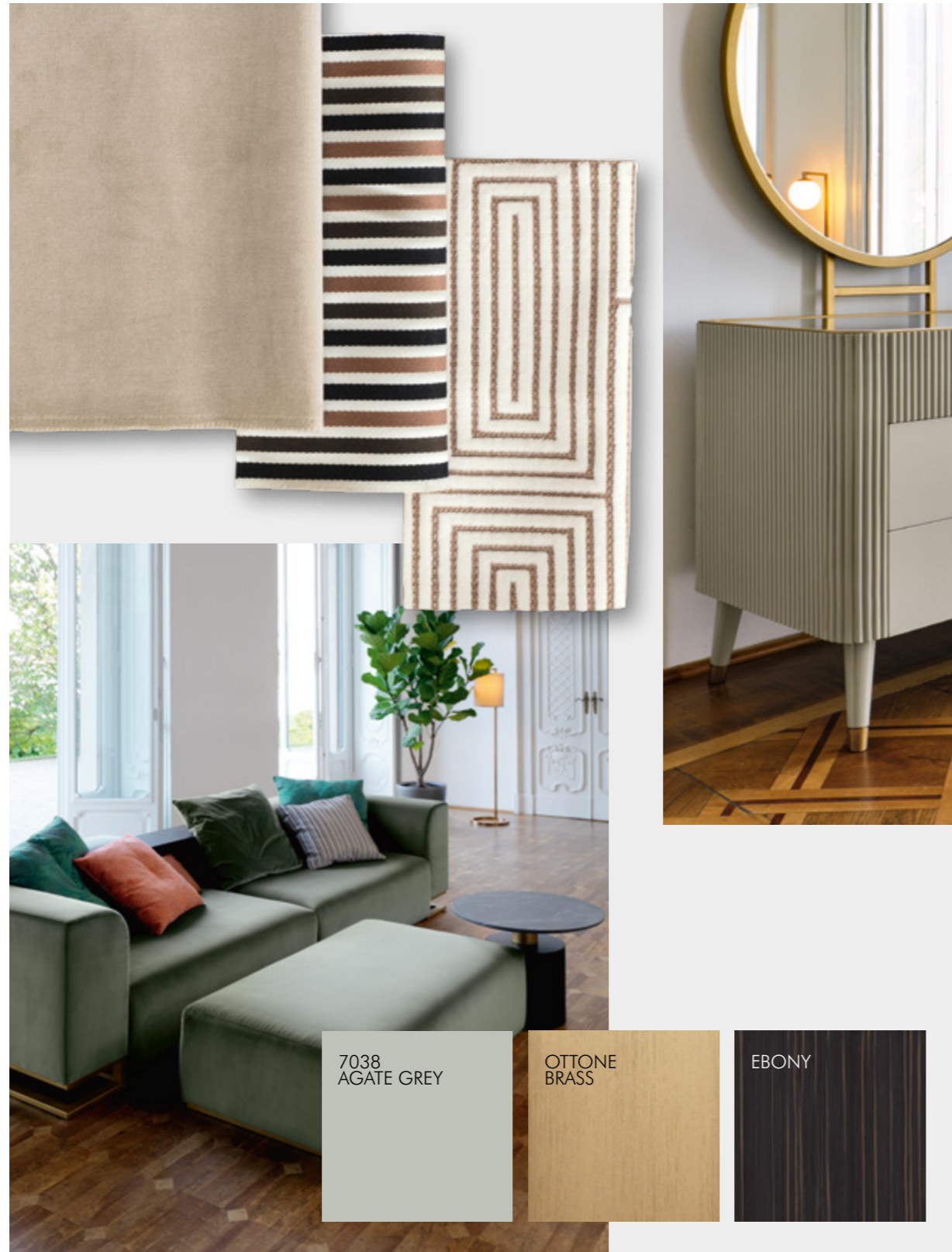

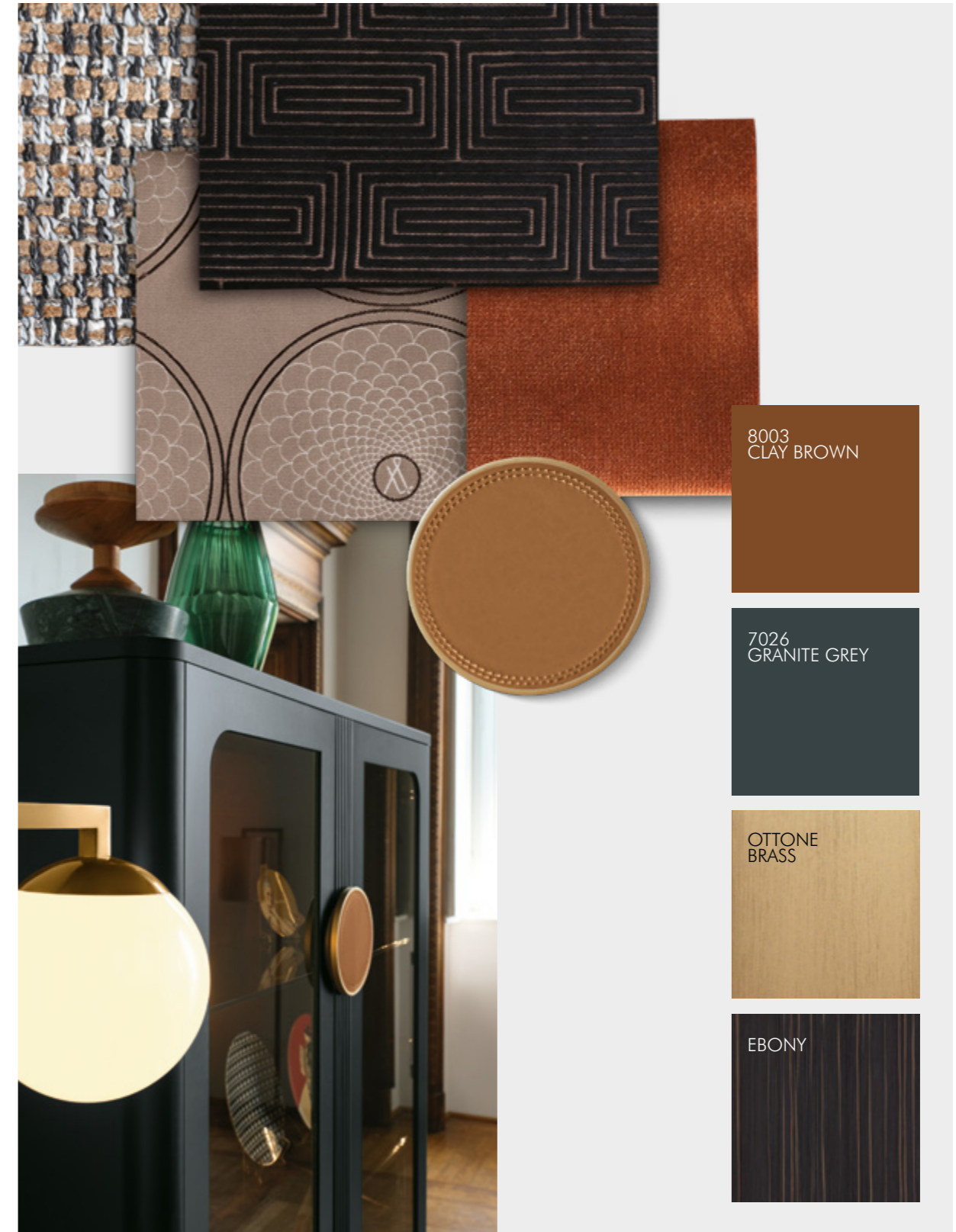
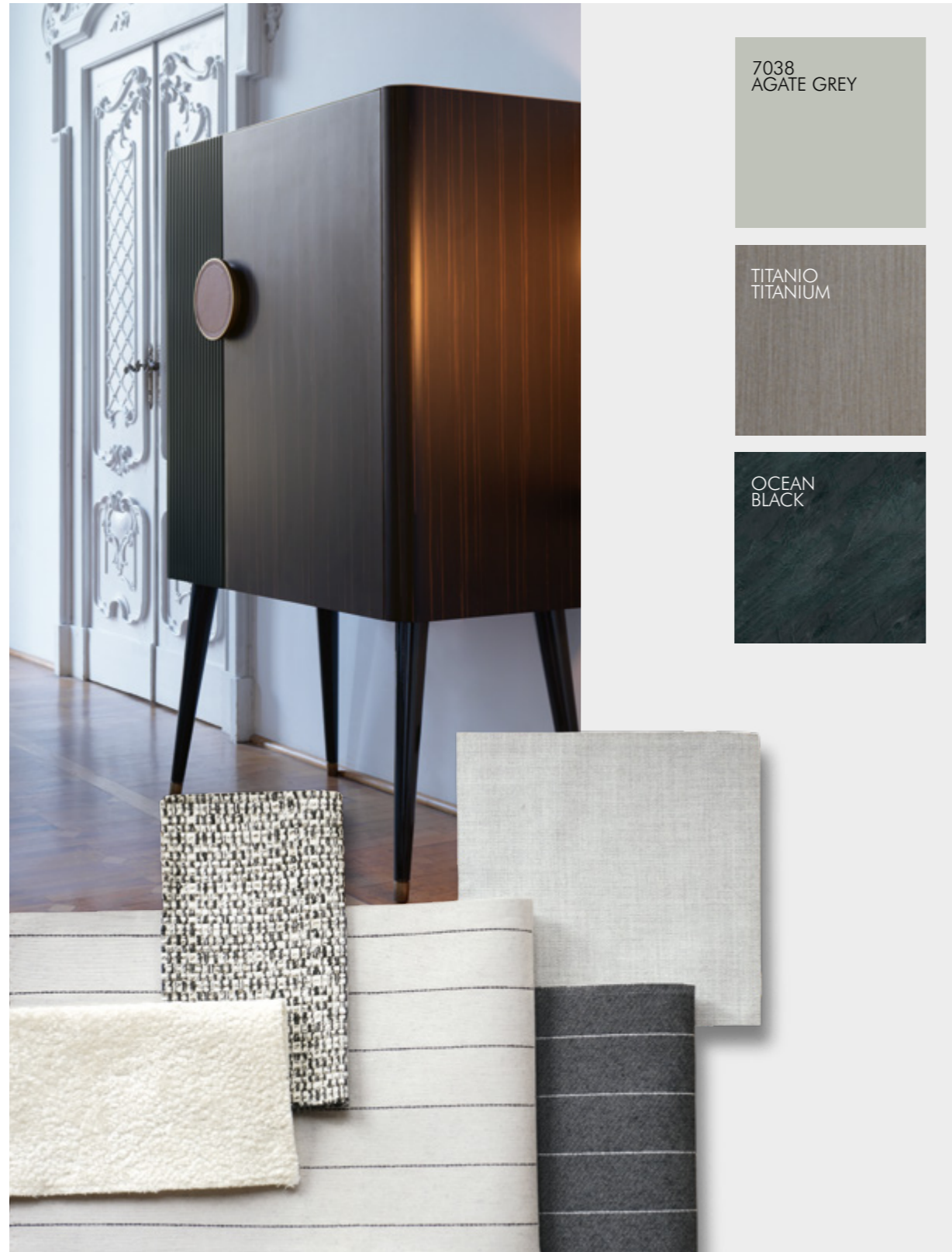

QUESTO CATALOGO È IL FRUTTO DELLA SINERGIA DI TUTTE LE PERSONE CHE SI VEDONO QUI A FIANCO. OGNUNA DI LORO, PER LA PROPRIA COMPETENZA, HA MESSO AL SERVIZIO DEL RISULTATO FINALE IL SUO IMPEGNO, LA SUA PASSIONE E LA SUA PROFESSIONALITÀ. LA LOCATION PRESTIGIOSA E STRAORDINARIA HA CONTRIBUITO A RENDERE IL LAVORO STIMOLANTE E GRATIFICANTE.

THIS CATALOGUE IS THE RESULT OF THE SINERGY OF ALL THE PEOPLE ON THE SIDE PICTURE. EACH ONE OF THEM WITH HIS OWN COMPETENCE, WITH PASSION AND PROFESSIONALISM, GAVE A PRECIOUS CONTRIBUTE FOR THE ACHIEVEMENT OF THIS PROJECT. THE AMAZING AND PRESTIGIOUS LOCATION CONTRIBUTED TO MAKE A CHALLENGING AND REWARDING JOB.



CREDITI / CREDITS

Designer

Ottomani design

Art direction + Graphic design

Adhoc spazio creativo

Photography

Lorenzo Borgianni

Print

Grafiche Antiga Spa

THANKS TO

Gumdesign

Karpeta tappeti

Tondo Fiorentino

Editions Milano

Texturae

© Scappini & C srl - Maggio 2022

SCAPPINI

H O M E

SCAPPINI & C Srl
Via della Serenissima, 9
37051 Bovolone (Verona) - Italy
Tel. +39 045 710 3611
Fax +39 045 710 3637
scappini@scappini.it

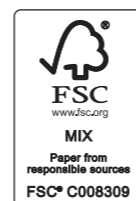

scappinihome.it